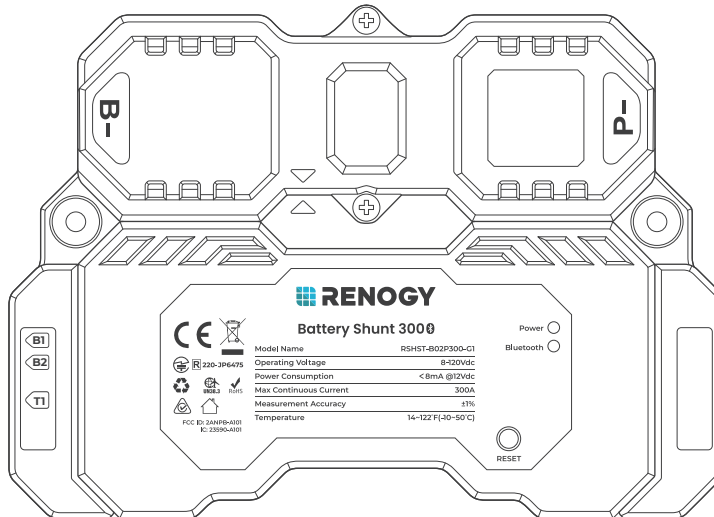

RENOGY

Battery Shunt 300

RSHST-B02P300-C1

VERSION A2
January 5, 2024

QUICK GUIDE

Before Getting Started

The quick guide provides important operation and maintenance instructions for Renogy Battery Shunt 300 (hereinafter referred to as shunt).

Read the quick guide carefully before operation and save it for future reference. Failure to observe the instructions or precautions in the quick guide can result in electrical shock, serious injury, or death, or can damage the shunt, potentially rendering it inoperable.

- Renogy ensures the accuracy, sufficiency, and the applicability of information in the quick guide at the time of printing due to continual product improvements that may occur.
- Renogy assumes no responsibility or liability for personal and property losses, whether directly and indirectly, caused by the user's failure to install and use the product in compliance with the quick guide.
- Renogy is not responsible or liable for any failure, damage, or injury resulting from repair attempts by unqualified personnel, improper installation, or inappropriate operation.
- The illustrations in the quick guide are for demonstration purposes only. Details may appear slightly different depending on product revision and market region.
- Renogy reserves the right to change the information in the quick guide without notice. For the latest quick guide, visit [renogy.com](https://www.renogy.com).

Online Manual

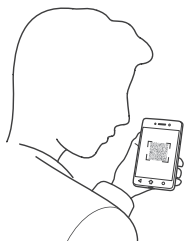

Quick Guide



User Manual

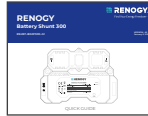
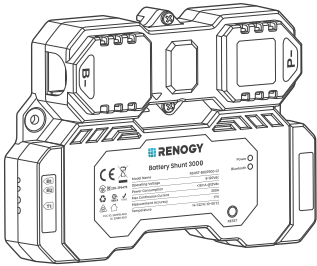

Table of Contents

What's In the Box?	1
Dimensions	1
Get to Know Renogy Battery Shunt 300	2
Renogy Battery Shunt 300 System Setup	3
Required Tools & Accessories	4
How to Size Bare Wires?	5
Check System Voltage and Current	5
Step 1. Plan a Mounting Site	6
Step 2. Wear Insulating Gloves	6
Step 3. Remove the Covers	7
Step 4. Connect the Shunt to the Main Battery Negative	8
Step 5. Connect the Shunt to the Device BAT-	9
Step 6. Connect the Shunt to the Main Battery Positive	10
Step 7. Connect the Shunt to the Starter Battery Positive (Optional)	11
Step 8. Install a Battery Temperature Sensor	12
Step 9. Mount the Shunt (Optional)	12
Step 10. Install the Covers	13
Step 11. Power On	14
LED Indicators	14
Bluetooth Pairing	15
Energy Monitoring	16
Troubleshooting	19
Important Safety Instructions	20
Renogy Support	21

What's In the Box?

Renogy Battery Shunt 300 x 1



Quick Guide x 1

ST4 x 18 mm

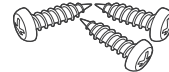

Mounting Screws x 3
(1 extra)

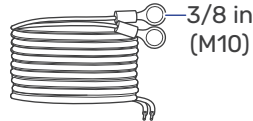

B1/B2 Wires (1 m) (22 AWG) x 2

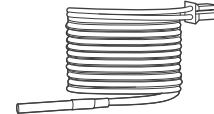

Temperature Sensor (1.5 m) x 1



Make sure that all accessories are complete and free of any signs of damage.

Dimensions

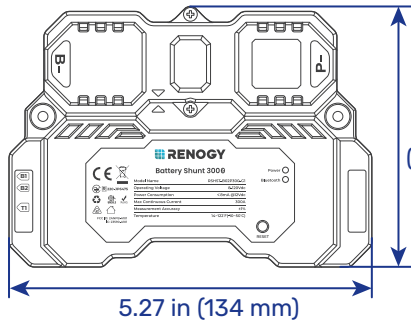

1.22 in (31 mm)

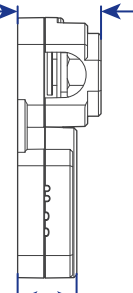

0.87 in (22 mm)



Dimension tolerance: ± 0.2 in (0.5 mm)

Get to Know Renogy Battery Shunt 300

Exterior

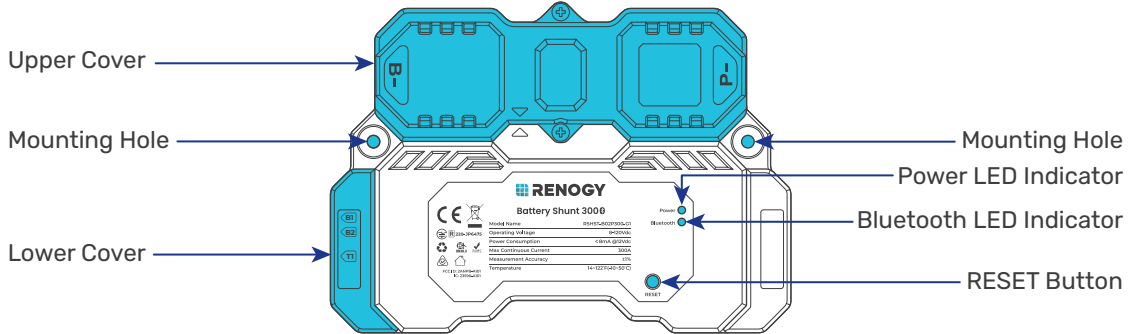

Interior (with the covers removed)

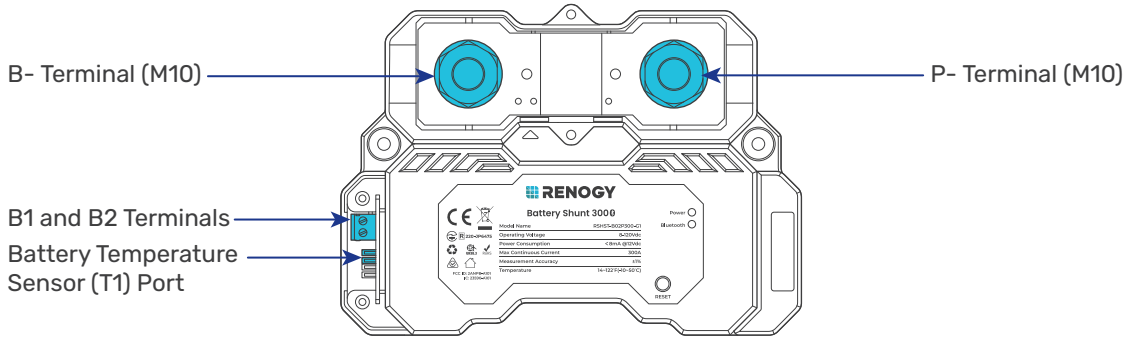

Renogy Battery Shunt 300 System Setup

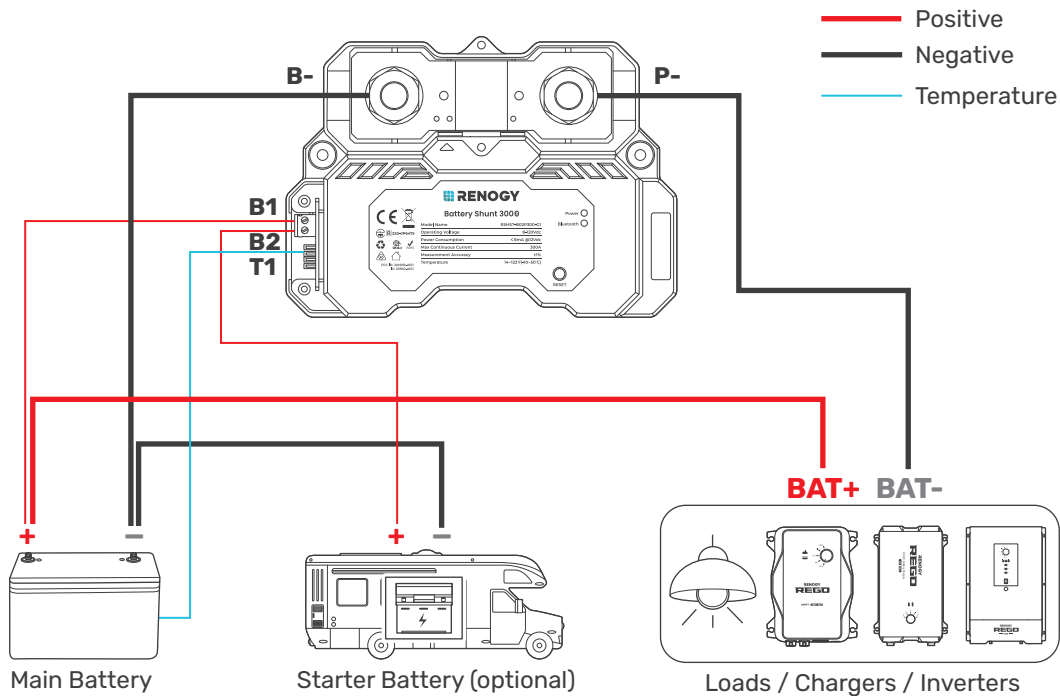

You can connect the Battery Shunt 300 to a starter battery via the B2 port on demand.

Required Tools & Accessories

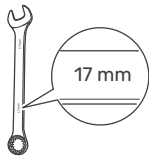

Wrench
(11/16 in)



Phillips
Screwdriver (#1)



Slotted
Screwdriver (1 mm)

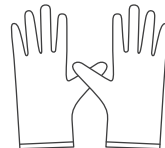

Insulating Gloves



Wire stripper

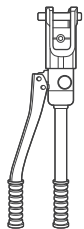

Manual Hydraulic
Pliers

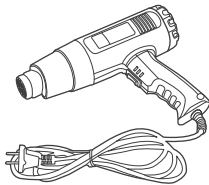

Heat Gun

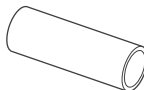





Heat Shrink Tubing



Bare Wires × 2



3/8 in Lugs
(M10 Ring Terminals) × 2

-  Prior to installing and configuring the shunt, prepare the recommended tools, components, and accessories.
-  For how to size bare wires, refer to "[How to Size Bare Wires?](#)" in this manual.
-  For the connection methods and required tools for the main battery, starter battery, and equipment terminal, please refer to the corresponding device user manual. The diagrams provided within this manual are for illustrative purposes only.
-  For how to use Wire stripper, Heat Shrink Tubing, Manual Hydraulic Pliers, and Heat Gun to install 3/8 in Lugs (M10 Ring Terminals), visit renogy.com/support/downloads to check Battery Shunt User Manual.

How to Size Bare Wires?

Select proper bare wires based on the ampacity in your power system. Refer to the table below for copper cable ampacities with different gauge sizes.

Cable Gauge Size	Ampacity	Cable Gauge Size	Ampacity
14 AWG (2.08 mm ²)	35A	2 AWG (33.6 mm ²)	190A
12 AWG (3.31 mm ²)	40A	1 AWG (42.4 mm ²)	220A
10 AWG (5.25 mm ²)	55A	1/0 AWG (53.5 mm ²)	260A
8 AWG (8.36 mm ²)	80A	2/0 AWG (67.4 mm ²)	300A
6 AWG (13.3 mm ²)	105A	4/0 AWG (107 mm ²)	405A
4 AWG (21.1 mm ²)	140A		



The above values are from the NEC Table 310.17 for copper cables rated at 194°F (90°C), operating at an ambient temperature of no more than 86°F (30°C). Cables longer than 13 feet (4000 mm) may require thicker gauge wires to prevent excessive voltage drop in undersized wiring.

Check System Voltage and Current

Ensure the battery shunt operates within a power system with a maximum system voltage of 120V and a continuous current of up to 300A. Exceeding these voltage and current limits may cause damage to the shunt.



Risk of electric shock! Before installing the shunt, please turn off all devices within the system and ensure there is no current flowing through the circuit.

Step 1. Plan a Mounting Site

Select a proper mounting site to ensure the shunt can be safely connected to the battery and other necessary devices with the relevant cables. Install the shunt in a clean, cool, and dry location, free from any accumulation of water, oil, or dirt. For optimal Bluetooth communication, avoid placing the battery shunt near metal objects.

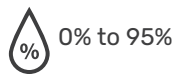
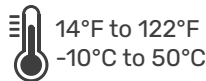
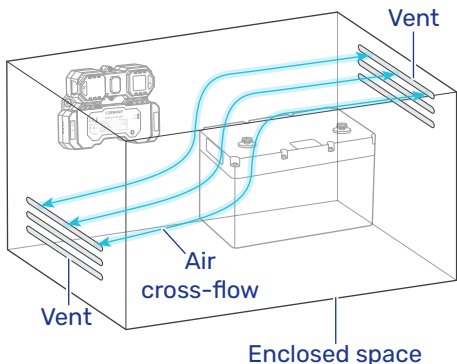

Step 2. Wear Insulating Gloves

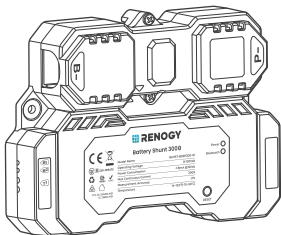

Insulating Gloves

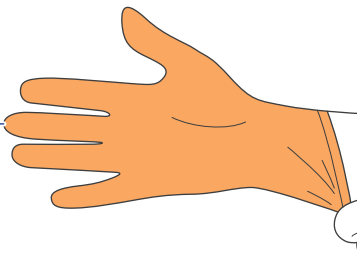

Step 3. Remove the Covers

Remove the Upper Cover

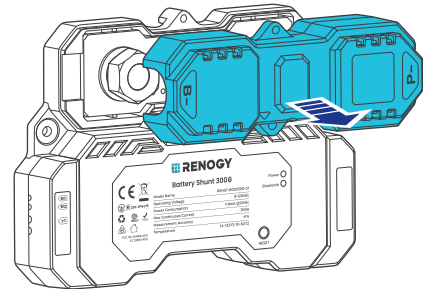
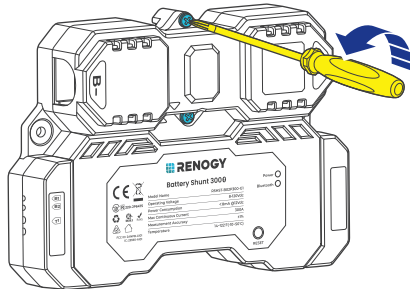

Remove the Lower Cover

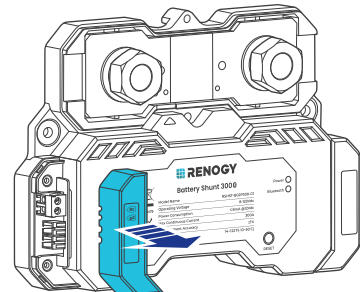
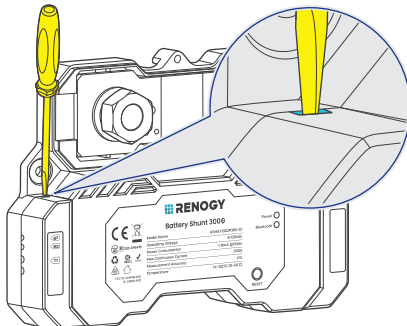

Step 4. Connect the Shunt to the Main Battery Negative

STEP-1 Install the bare wire on the shunt B- terminal.

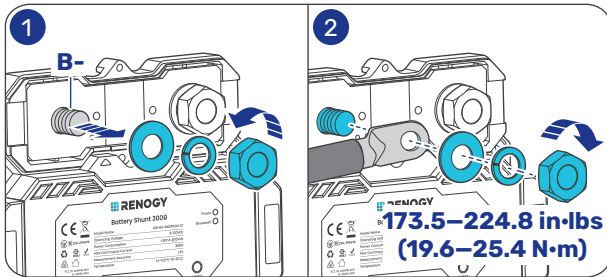

Renogy Battery Shunt 300

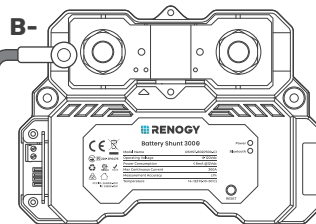

Bare Wire

STEP-2 Install the bare wire on the battery negative.

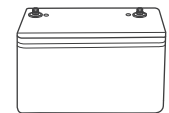
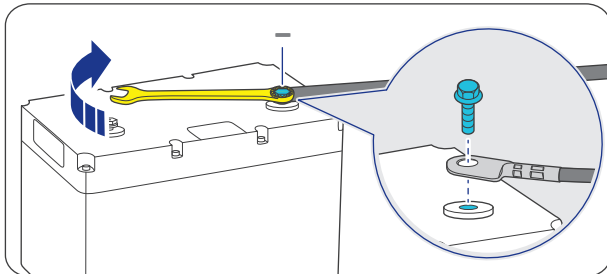

Main Battery

! You can connect a main battery to the B- terminal because connecting other devices to this terminal may affect the shunt's accuracy in current detection.

! For how to connect batteries in series or parallel to the battery shunt, refer to the Battery Shunt User Manual by scanning the QR code in the preface of the guide or at www.renogy.com/support/downloads.

Step 5. Connect the Shunt to the Device BAT-

STEP-1 Install the bare wire on the shunt P- terminal.

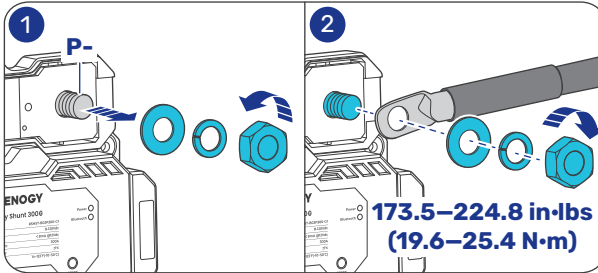

Renogy Battery Shunt 300

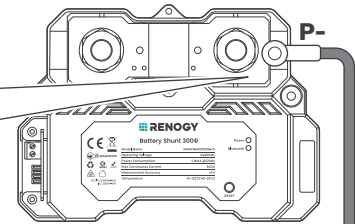

Bare Wire

STEP-2 Install the bare wire on the device BAT-.

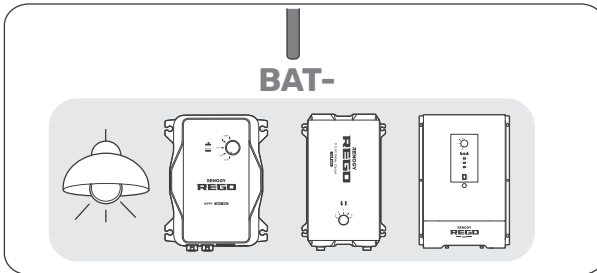

BAT-

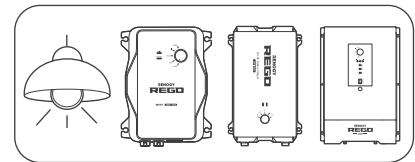

Loads & Charges & Inverters

Step 6. Connect the Shunt to the Main Battery Positive

STEP-1 Install the B+ wire on the shunt B1 terminal.

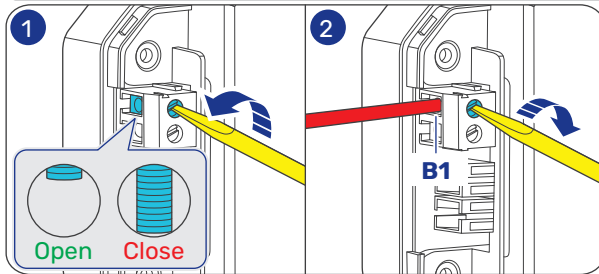

Renogy Battery Shunt 300

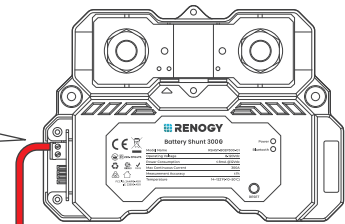

B1 Wire

STEP-2 Install the B+ wire on the main battery positive.

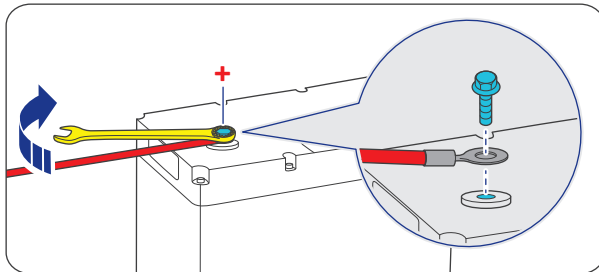

Main Battery

Step 7. Connect the Shunt to the Starter Battery Positive (Optional)

STEP-1 Install the B+ wire on the shunt B2 terminal.

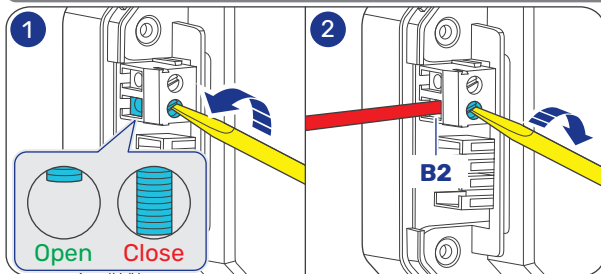

Renogy Battery Shunt 300

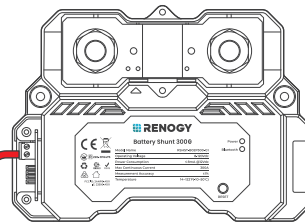

B2 Wire

STEP-2 Install the B+ wire on the starter battery positive.

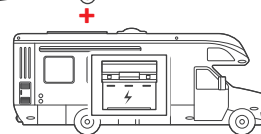
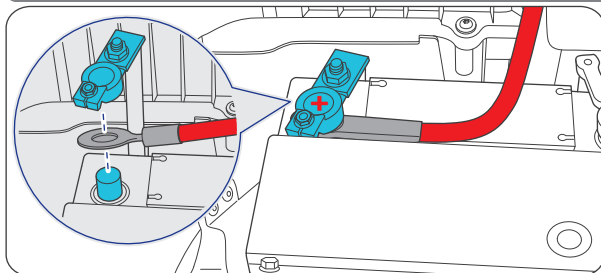

Starter Battery

Step 8. Install a Battery Temperature Sensor

The temperature sensor measures the temperature of the main battery and sends the temperature value to the DC Home app. The app displays a low/high temperature alarm when the battery temperature reaches a preset limit.

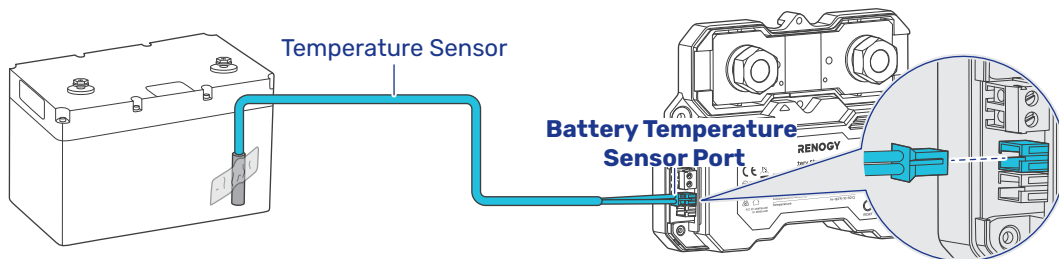

Step 9. Mount the Shunt (Optional)

You have the flexibility to select a suitable mounting method based on your preference. You can opt to mount it on a wall, the floor, or even use a floating installation approach.

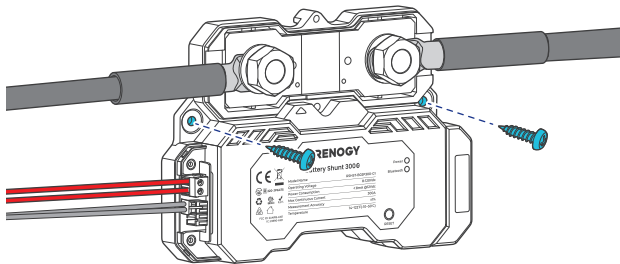

Step 10. Install the Covers

Install the Lower Cover

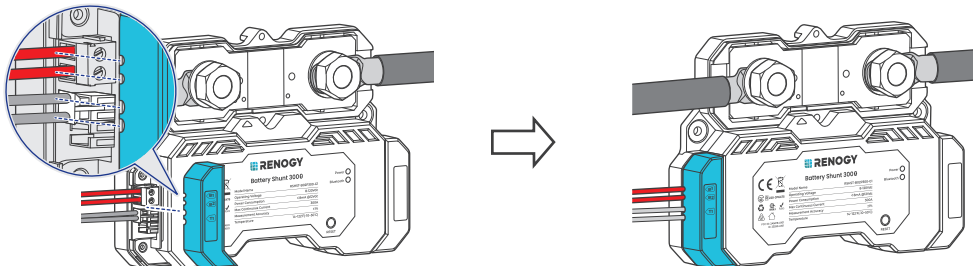

Install the Upper Cover (Optional)

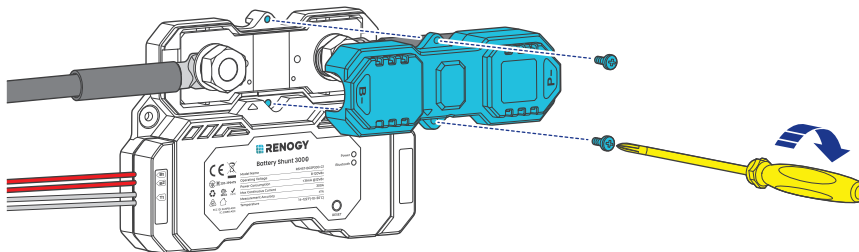

Installing the Upper Cover is optional in cases where the terminals are not enclosed by the cover.

Step 11. Power On

Power on all devices in your power system, and the Battery Shunt is powered up automatically with the Power LED Indicator lighting up.



If the Power LED Indicator fails to illuminate, please inspect the cables for any signs of short circuits or loose connections. If the issue persists, please reach out to our technical support team via renogy.com/contact-us.

LED Indicators

Power LED Indicator

- **Off:** Power Off
- **Solid:** Power On

Power



Bluetooth



Bluetooth LED Indicator

- **Off:** No Bluetooth device connected
- **Solid:** Bluetooth connected

Bluetooth Pairing

 To ensure optimal system performance, keep the phone or RENOGY ONE Core within 10 feet (3 m) of the shunt.

Initial Pairing:

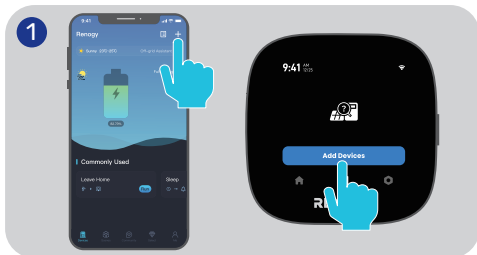

1. Open the app or RENOGY ONE Core.

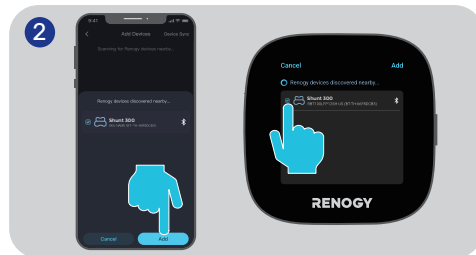

2. Search and pair the Battery Shunt.

Pairing with Other Devices:

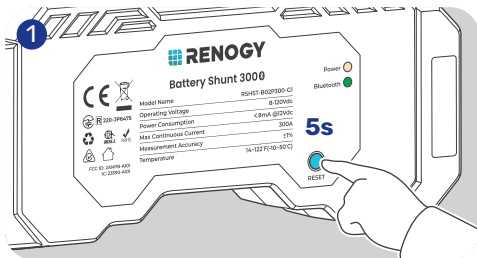

1. Remove the shunt from the DC Home app or ONE. Alternatively, you can press and hold RESET on the shunt for 5s.

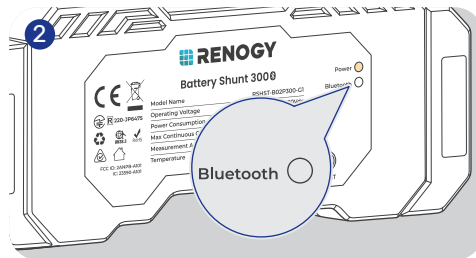

2. The Bluetooth LED turns off. Re-scan and pair the shunt with other devices.

Energy Monitoring

Depending on the specific application, the shunt can establish either short-range or long-range communication connections with monitoring devices. These monitoring devices including RENOGY ONE Core and DC Home facilitate real-time monitoring, programming, and complete system management, offering comprehensive control and enhanced flexibility.



The version of the DC Home app might have been updated. Illustrations in the user manual are for reference only. Follow the instructions based on the current app version.

Download and login to the DC Home app.



DC Home App



Short-Range Monitoring via DC Home App

For initial use, set the “Rated Battery Ah” (rated battery capacity) on the app prior to other operations.

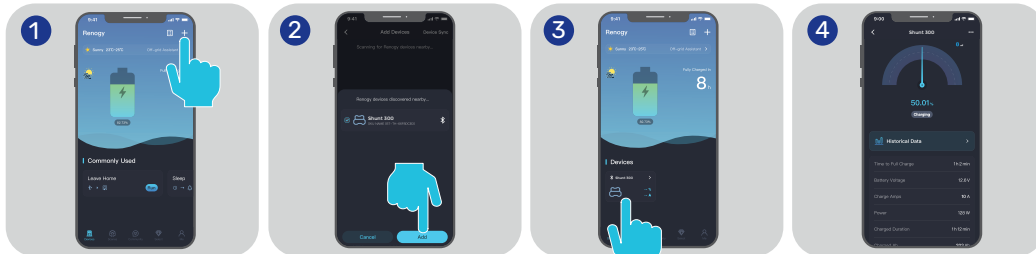

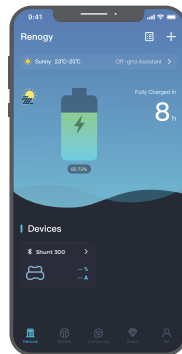
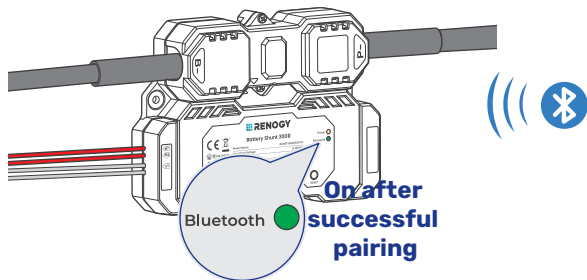

Wireless Long-Range Monitoring

If long-range communication and programming are required, connect the shunt to RENOLOGY ONE Core (sold separately) through Bluetooth, and the RENOLOGY ONE Core to the DC Home app through Wi-Fi.

Recommended Components



*RENOLOGY ONE Core

- ⚠ Components marked with "*" are available on [renogy.com](https://www.renogy.com).
- ⚠ For instructions on Renogy ONE Core, see [Renogy ONE Core User Manual](#).
- ⚠ Make sure the shunt does not communicate with any other device.

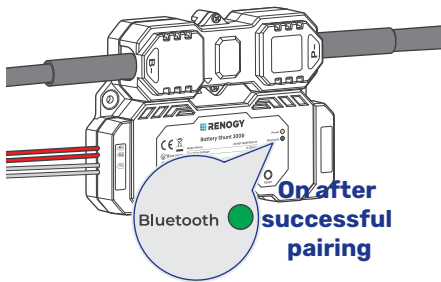
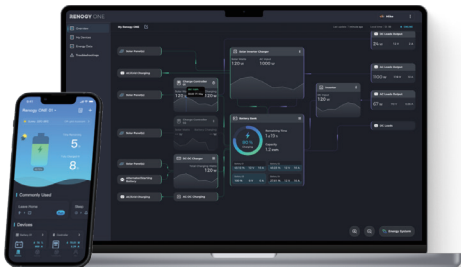

Troubleshooting

You can receive fault alarms on DC Home and RENOGY ONE Core when the shunt is faulty. Please login to the DC Home app or RENOGY ONE Core for troubleshooting details.

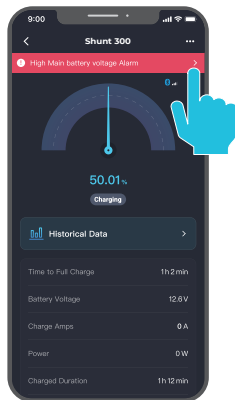

To access troubleshooting details, check Battery Shunt User Manual at renogy.com/support/downloads.



For technical support, contact our technical service through renogy.com/contact-us.

Important Safety Instructions

General

- Wear proper protective equipment and use insulated tools during installation and operation. Do not wear jewelry or other metal objects when working on or around the shunt.
- Keep the shunt out of the reach of children.
- Do not dispose of the shunt as household waste. Comply with local, state, and federal laws and regulations and use recycling channels as required.
- In case of fire, put out the fire with a FM-200 or CO₂ fire extinguisher.
- Do not expose the shunt to flammable or harsh chemicals or vapors.
- Clean the shunt regularly.
- It is recommended that no cables should exceed 10 meters because excessively long cables result in a voltage drop.
- The cable specifications listed in the user manual account for critical, less than 3% voltage drop and may not account for all configurations.
- Do not expose the shunt to strong electrostatic fields, strong magnetic fields, or radiation.

Shunt Safety

- Please keep the shunt away from water, heat sources, sparks, and hazardous chemicals.
- Do not puncture, drop, crush, burn, penetrate, shake, strike, or step on the shunt.
- Do not open, dismantle, repair, tamper with, or modify the shunt.
- Do not touch any terminals or connectors.
- Please make sure all devices have been disconnected before working on the shunt.
- Do not insert foreign objects into the terminals of the shunt.
- You can connect a main battery to the B- terminal because connecting other devices to this terminal may affect the shunt's accuracy in current detection.

Renogy Support

To discuss inaccuracies or omissions in this quick guide or user manual, visit or contact us at:

 | renogy.com/support/downloads



contentservice@renogy.com

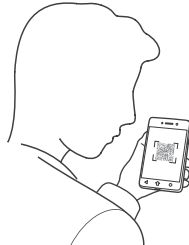

Questionnaire Investigation



To explore more possibilities of solar systems, visit Renogy Learning Center at:

 | renogy.com/learning-center



For technical questions about your product in the U.S., contact the Renogy technical support team through:

 | renogy.com/contact-us



1(909)2877111

For technical support outside the U.S., visit the local website below:

Canada |  | ca.renogy.com

China |  | www.renogy.cn

Australia |  | au.renogy.com

Japan |  | renogy.jp

South Korea |  | kr.renogy.com

Germany |  | de.renogy.com

United Kingdom |  | uk.renogy.com

Other Europe |  | eu.renogy.com

Disclaimer

Renogy Battery Shunt 300 Quick Guide © 2024 Renogy. All rights reserved.

RENOGY and **RENOCY** are registered trademarks of Renogy.

- All information in the quick guide is subject to copyright and other intellectual property rights of Renogy and its licensors. The quick guide may not be modified, reproduced, or copied, in whole or in part, without the prior written permissions of Renogy and its licensors.
- The registered trademarks in the quick guide are the property of Renogy. The unauthorized use of the trademarks is strictly prohibited.

FCC Statement

This device complies with Part 15 of the FCC Rules. Operation is subject to the following two conditions:

- (1) This device may not cause harmful interference.
- (2) This device must accept any interference received, including interference that may cause undesired operation.

Any Changes or modifications not expressly approved by the party responsible for compliance could void the user's authority to operate the equipment.

This equipment has been tested and found to comply with the limits for a Class B digital device, pursuant to Part 15 of the FCC Rules. These limits are designed to provide reasonable protection against harmful interference in a residential installation. This equipment generates, uses and can radiate radio frequency energy and, if not installed and used in accordance with the instructions, may cause harmful interference to radio communications. However, there is no guarantee that interference will not occur in a particular installation. If this equipment does cause harmful interference to radio or television reception, which can be determined by turning the equipment off and on, the user is encouraged to try to correct the interference by one or more of the following measures:

- (1) Reorient or relocate the receiving antenna.
- (2) Increase the separation between the equipment and receiver.
- (3) Connect the equipment into an outlet on a circuit different from that to which the receiver is connected.
- (4) Consult the dealer or an experienced radio / TV technician for help.

FCC Radiation Exposure Statement

This equipment complies with FCC radiation exposure limits set forth for an uncontrolled environment. This equipment should be installed and operated with minimum distance 20cm between the radiator & your body.



Renogy Empowered

Renogy aims to empower people around the world through education and distribution of DIY-friendly renewable energy solutions.

We intend to be a driving force for sustainable living and energy independence.

In support of this effort, our range of solar products makes it possible for you to minimize your carbon footprint by reducing the need for grid power.



Live Sustainably with Renogy

Did you know? In a given month, a 1kW solar energy system will...



Save 170 pounds of coal from being burned



Save 300 pounds of CO₂ from being released into the atmosphere



Save 105 gallons of water from being consumed



Renogy Power PLUS

Renogy Power Plus allows you to stay in the loop with upcoming solar energy innovations, share your experiences with your solar energy journey, and connect with like-minded people who are changing the world in the Renogy Power Plus community.

Renogy reserves the right to change the contents of this quick guide without notice.

Manufacturer: RENOGY New Energy Co.,Ltd
Address: No.66, East Ningbo Road Room 624-625
Taicang German Overseas Students Pioneer Park
JiangSu 215000 CN

Manufacturer: RENOGY New Energy Co.,Ltd
Address: No.66, East Ningbo Road Room 624-625
Taicang German Overseas Students Pioneer Park
JiangSu 215000 CN



eVatmaster Consulting GmbH
Battinistr. 30
60325 Frankfurt am Main, Germany
contact@evatmaster.com



EVATOST CONSULTING LTD
Suite 11, First Floor, Moy Road Business
Centre, Taffs Well, Cardiff, Wales, CF15 7QR
contact@evatmaster.com



FCC ID: 2ANPB-A101

IC: 23590-A101

RENOGY

