

REGO

DC-DC Battery Charger

12V | 60A

VERSION A0

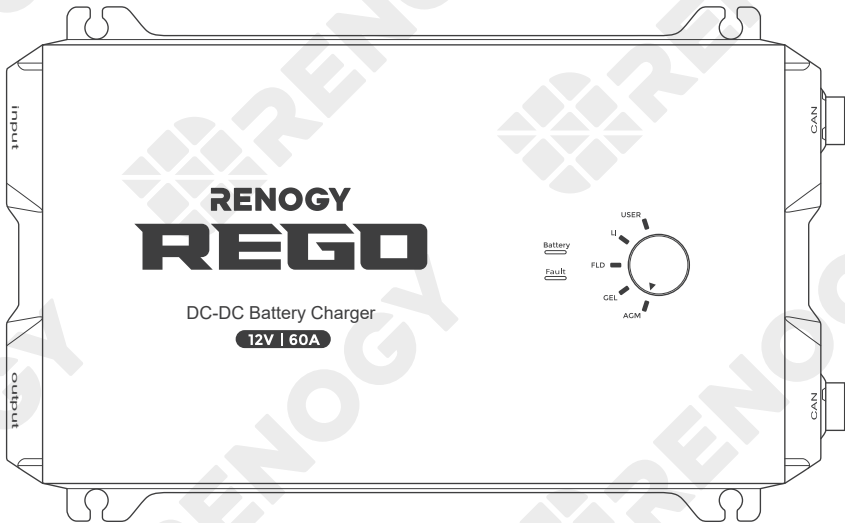

QUICK GUIDE



Contents

Package Contents.....	01
Wiring Diagram.....	02
Product Overview.....	03
Installation.....	04
LED Indicators.....	14
Communication.....	15
Operation & Maintenance.....	18

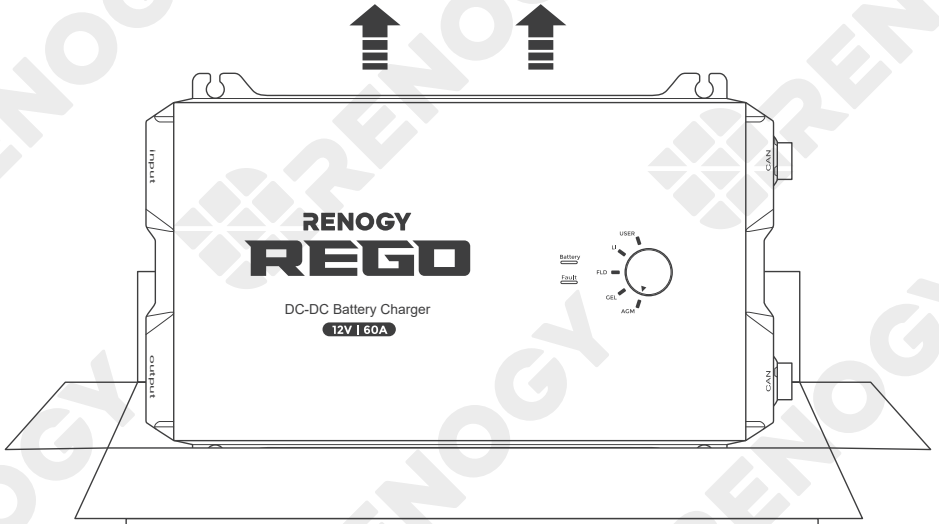

Package Contents

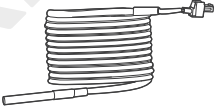

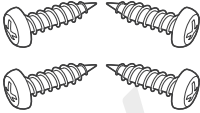
Quick Guide × 1	Renogy Temperature Sensor × 1 (Model: RTSCC)	IGN Signal Wire × 1	Screws × 4
			



Wiring Diagram

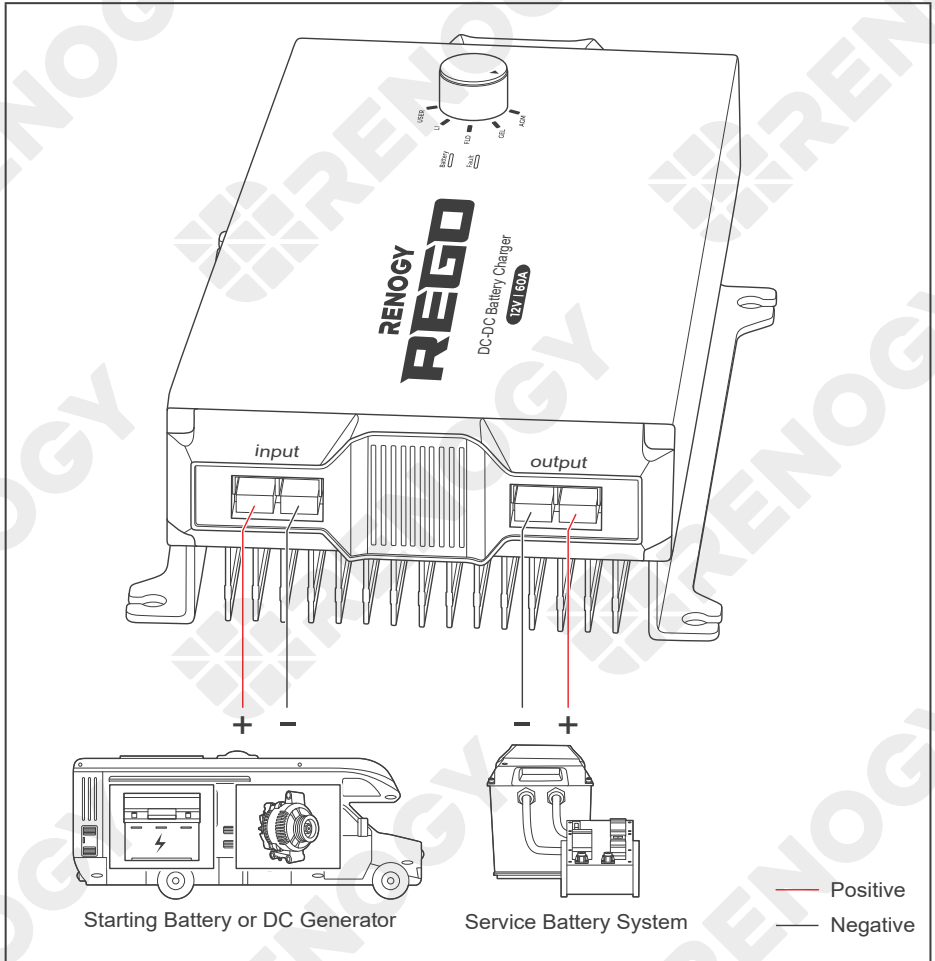

- This Quick Guide contains important installation, operation, and maintenance instructions for REGO 12V 60A DC-DC Battery Charger. Please read the Quick Guide carefully before using.
- Illustrations in the Quick Guide are for reference only.
- For more detailed instructions, please refer to the user manual at renogy.com.
- For additional support, please contact our customer service through renogy.com/contact-us/.



Product Overview

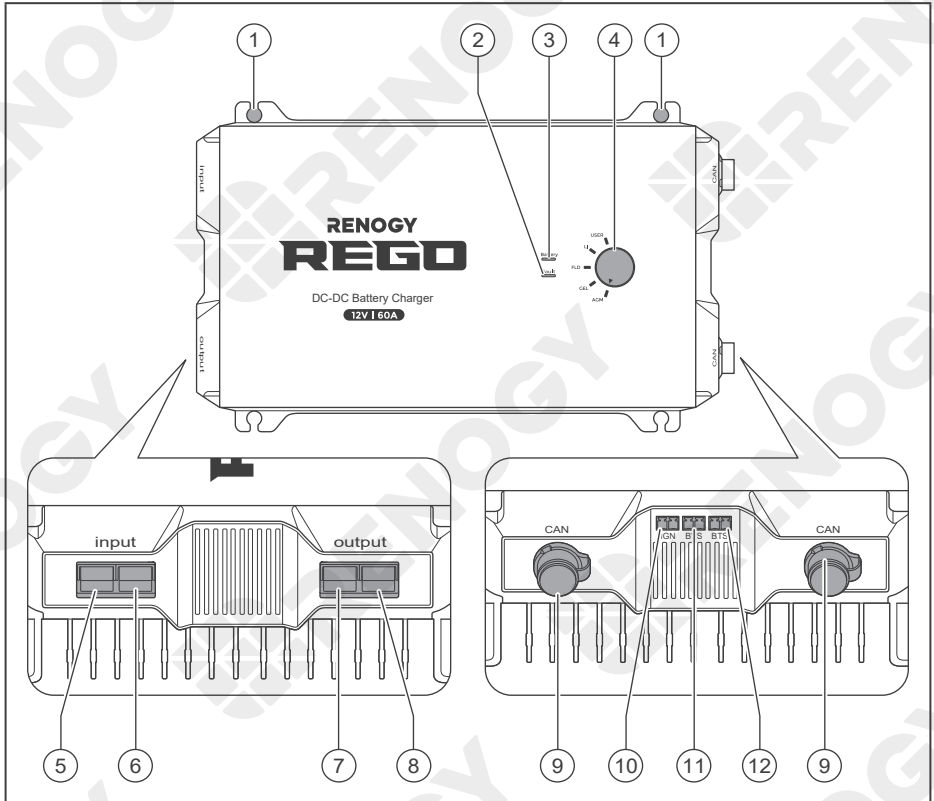

No.	Part	No.	Part
1	Mounting Holes	7	Negative Output Terminal
2	Fault Status Indicator	8	Positive Output Terminal
3	Battery Status Indicator	9	CAN Communication Ports
4	Battery Type Setting Knob	10	IGN Signal Wire Port
5	Positive Input Terminal	11	BVS (Battery Voltage Sensor) Port
6	Negative Input Terminal	12	BTS (Battery Temperature Sensor) Port



- Please inspect the battery charger for any visible damage including cracks, dents, deformation, and other visible abnormalities before installation.
- There are no user serviceable parts inside the battery charger. Do not disassemble or attempt to repair it.



Installation

Recommended Components

Battery Scenario A: REGO Battery Kit

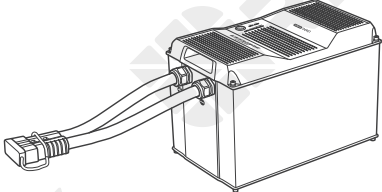
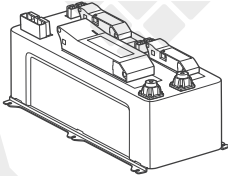
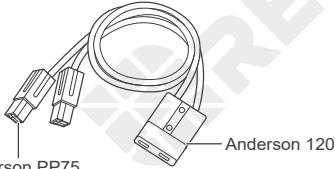
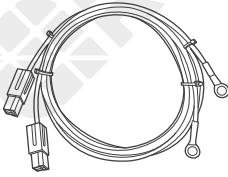
Renogy REGO Lithium Battery	Renogy REGO System Combiner Box
	
Battery Adapter Cable (output) (Anderson PP75 to Anderson 120 Adapter Cable)	Battery Adapter Cable (input) (Anderson PP75 to Ring Terminal Adapter Cable)
 <p>Anderson PP75</p> <p>Anderson 120</p>	

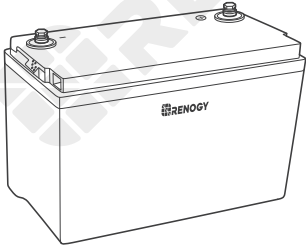
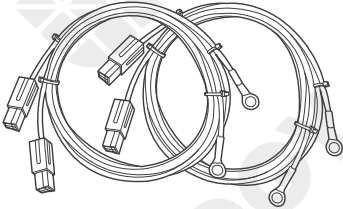

Battery Scenario B: Normal Battery Kit

Normal Battery with +/- Bolts	Battery Adapter Cables (input / output) (Anderson PP75 to Ring Terminal Adapter Cable)
	





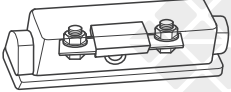

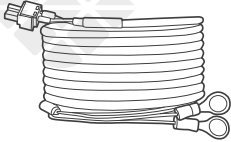

Installation

*Optional Accessories

*Battery Fuse (80A)	*Fuse Cable	*Battery Voltage Sensor (Model: RVSCC)
		

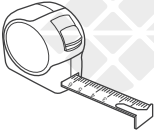
Required Tools

Wrench (10mm)	Wrench (14mm)	Measuring Tape	Insulation Tape
 	 		



Installation

Mounting Location



- Risk of explosion! Never install the battery charger in a sealed enclosure with flooded batteries! Do not install in a confined area where battery gases can accumulate.
- Place the battery charger on a vertical surface protected from direct sunlight, high temperatures, and water. Make sure there is good ventilation.
- The battery charger requires at least 6 inches (150mm) of clearance above and below for proper air flow. Ventilation is highly recommended if mounted in an enclosure.
- If the Battery Adapter Cable or Solar Panel Extension Cable is not long enough, you can use more extension cables or reselect the position where the battery charger needs to be secured.

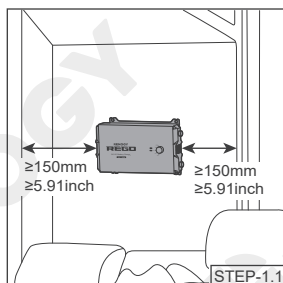

Confirm the installation location.

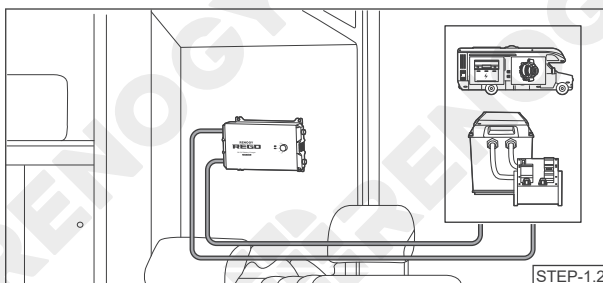

Measure the length of the cables connecting to the battery and solar panel so they can be connected to the battery charger.



Installation

Battery Charger Wiring



- Please refer to the user manual of the battery charger at renogy.com for the recommended wire gauge and length.
- Please make sure that the connections of the Anderson connectors are tight and secure.

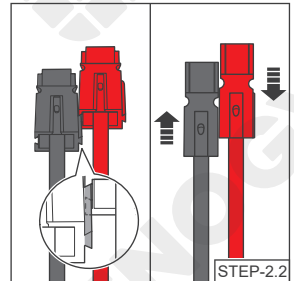
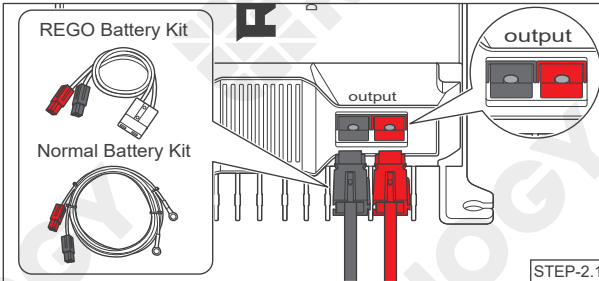

For the Output terminal, align the Battery Adapter Cable's Anderson PP75 connectors to the correct orientation and polarity.

Bind the Anderson PP75 connectors by sliding the side grooves.

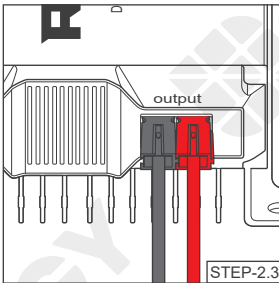

Insert the Anderson PP75 connectors into the Output terminal.

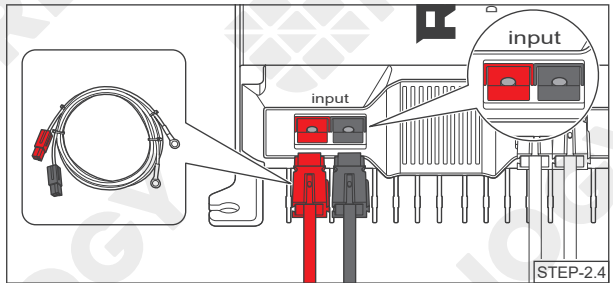

For the Input terminal, align the Battery Adapter Cable's Anderson PP75 connectors to the correct orientation and polarity.

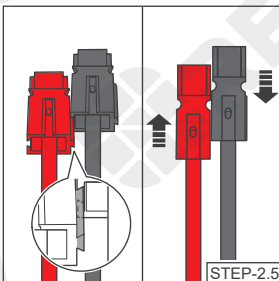

Bind the Anderson PP75 connectors by sliding the side grooves.

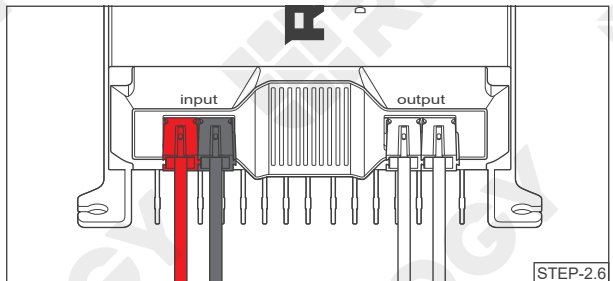

Insert the Anderson PP75 connectors into the Input terminal.



Installation

Service Battery Wiring



- Please read the user manual of the service battery carefully before installation.
- Identify the polarity (positive and negative) on the cables used for the batteries. A reverse polarity contact may damage the unit.
- Select a suitable wrench or other tool when tightening the battery bolts to their rated specification.
- Please ensure that the Anderson connectors are fully seated and/or the ring terminals are securely connected.

Battery Scenario A: REGO Battery Kit



- Please read the user manual of System Combiner Box carefully before wiring.
- If the devices are connected to the Anderson connectors of the System Combiner Box, please install a 160A NH fuse in the top NH fuse disconnect switch.
- If the Anderson PP75 to Ring Terminal Adapter Cable is used to connect with the System Combiner Box, please refer to the user manual of REGO 12V 60A DC-DC Battery Charger at renogy.com for more detailed instructions.
- If positive/negative busbars are used to connect with the normal service battery, please refer to the user manual of REGO 12V 60A DC-DC Battery Charger at renogy.com for more detailed instructions.

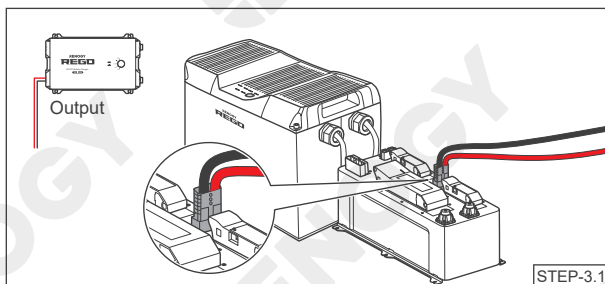

Insert the Anderson 120 connector of the Battery Adapter Cable (output) to the System Combiner Box.



Installation

Battery Scenario B: Normal Battery Kit

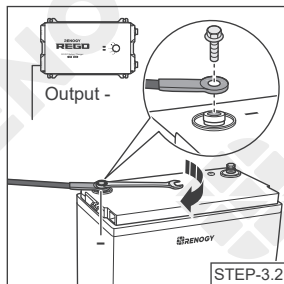

Attach the ring terminal of the negative Battery Adapter Cable (output) to the negative battery bolt and tighten with a wrench.

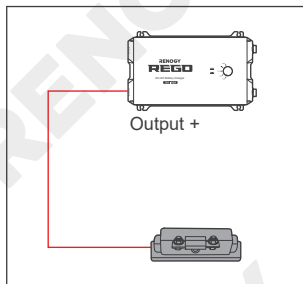

For your safety, it is recommended to use a battery fuse (80A). Connect the positive Battery Adapter Cable (output) to one end of the battery fuse, and then connect the other end to the positive bolt of the battery.

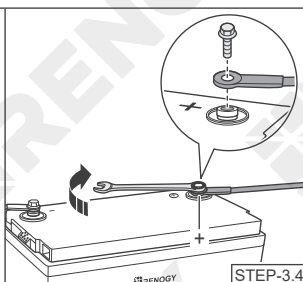
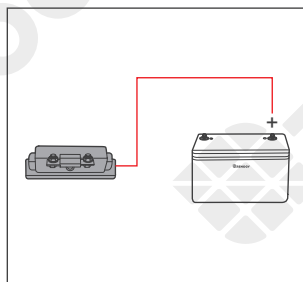
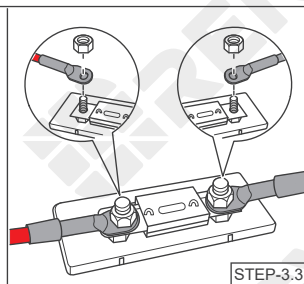

Attach the ring terminal of the positive Battery Adapter Cable (output) to the positive bolt of the service battery and tighten with a wrench.

Battery Indicator

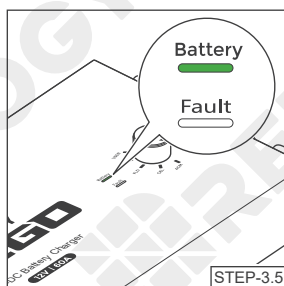

Once the battery wiring is completed correctly and the battery is turned on, the battery charger's Battery indicator lights up green.

If the Battery indicator does not light up, please refer to the user manual of the battery charger at renogy.com for troubleshooting instructions.



Installation

Input Wiring

The battery charger input terminal can be directly connected to the vehicle's starting battery or DC generator. If you want to wire directly to the DC generator, please refer to the user manual of REGO 12V 60A DC-DC Battery Charger at renogy.com for more detailed instructions.



- Please check the vehicle's manual to identify the generator type before connecting. If you cannot identify the generator type, please refer to the user manual of battery charger at renogy.com for more detailed instructions.
- The starting voltage of the battery charger input terminal depends on the generator type. If it is a smart generator, the starting voltage should be greater than 12.5V; if it is a traditional generator, the starting voltage should be greater than 13.5V.
- Identify the polarity (positive and negative) on the cables used for the batteries. A reverse polarity contact may damage the unit.
- Select a suitable wrench or other tool when tightening the battery bolts to their rated specification.
- Please ensure that the ring terminals are securely connected.

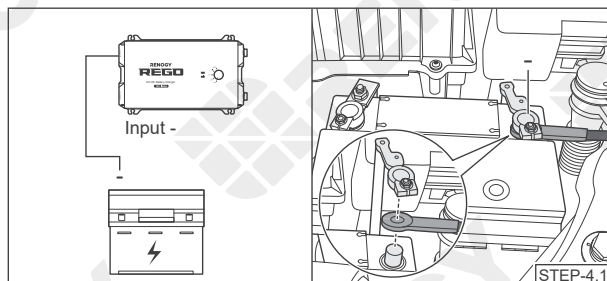

Attach the ring terminal of the negative Battery Adapter Cable (input) to the negative bolt of the starting battery.

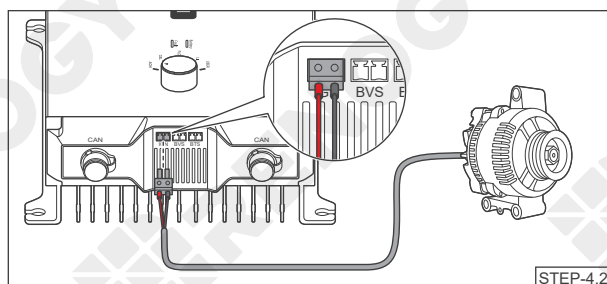

If the DC generator of the vehicle is a smart generator, insert the IGN Signal Wire connector into IGN signal wire port, and then connect the other end to the smart generator's ignition signal port.



Installation

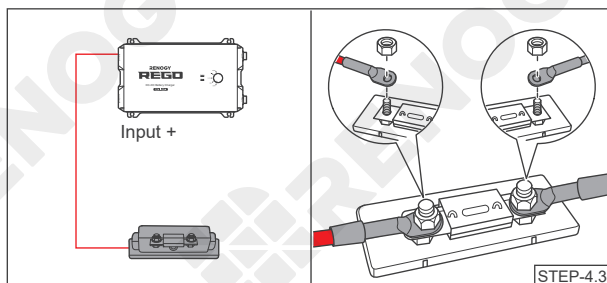

For your safety, it is recommended to use a battery fuse (80A). Connect the positive Battery Adapter Cable (input) to one end of the battery fuse, and then connect the other end to the positive bolt of the starting battery.

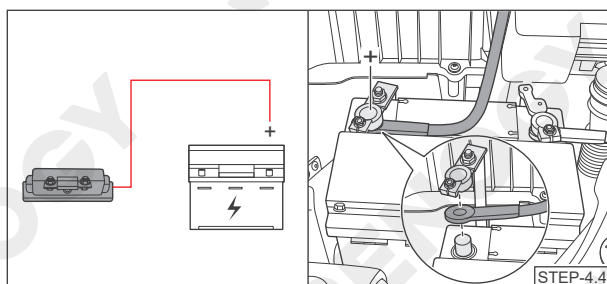

Attach the ring terminal of the positive Battery Adapter Cable (input) to the positive bolt of the starting battery and tighten with a wrench.

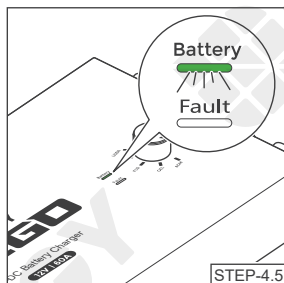

After waiting for 15S, the Battery indicator flashes green and the battery charger starts to work.

If the Battery indicator does not light up, please refer to the user manual of the battery charger at renogy.com for troubleshooting instructions.



Installation

Mounting



- Please make sure that the battery charger is installed firmly to prevent it from falling off.

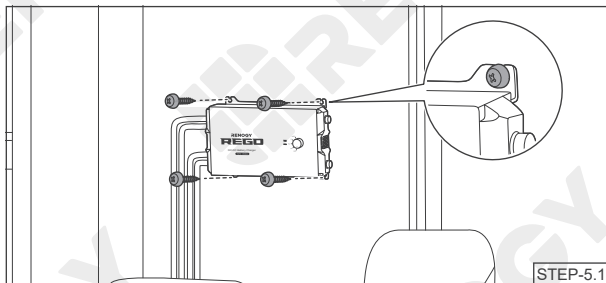

Place the battery charger against a flat surface and secure it with included screws.

Temperature Sensor



- The temperature sensor can detect the battery's temperature and update it to the battery charger for charging voltage calibration. This ensures the battery charger (with operating temperature range from -20°C to 60°C or -4°F to 140°F) can charge the battery normally.
- Do not use the temperature sensor on a LiFePO₄ (LFP) battery which comes with a battery management system (BMS).
- Please refer to the user manual of battery charger at renogy.com for more matters needing attention.

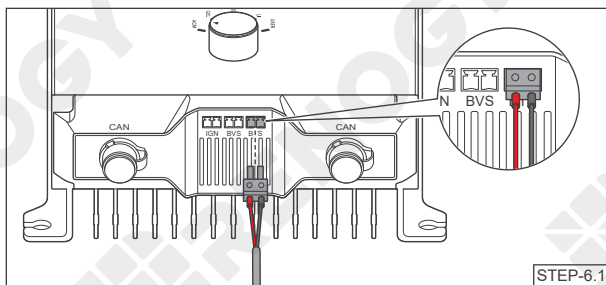

Insert the temperature sensor terminal block into the BTS port of the battery charger.

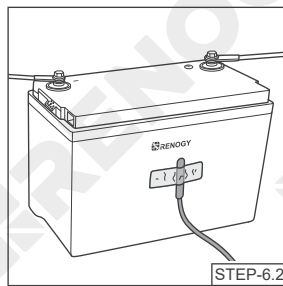

Adhere the sensor on the top or side of the battery with insulation tape.



Installation

*Voltage Sensor (Optional)

The Battery Voltage Sensor is the perfect solution by providing an accurate battery voltage to the battery charger and allowing it to adjust the charging stage precisely resulting in overall extension of your battery life.



- Identify the polarity (positive and negative) on the cables used for the batteries. A reverse polarity contact may damage the unit.
- The voltage sensor ring terminal is M8 (Approx. 5/16"). If the battery bolt size is small, please use a gasket to fix it to prevent it from falling off.

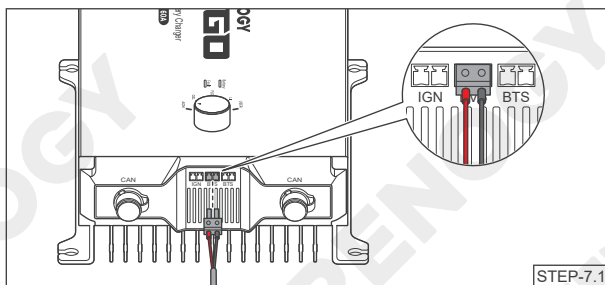

Insert the voltage sensor terminal block to the BVS port.

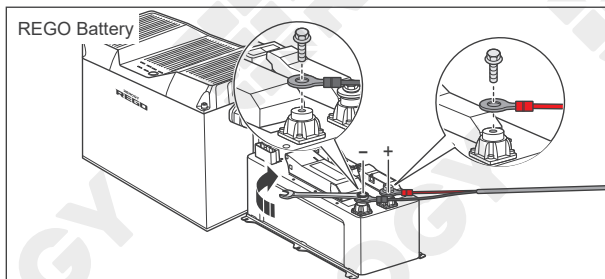

Connect the voltage sensor ring terminal to the positive/negative pole of the battery system.

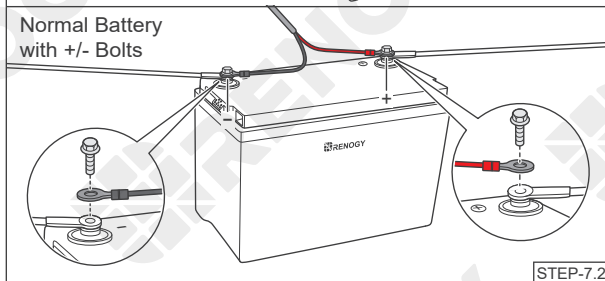



Battery Status Indicator

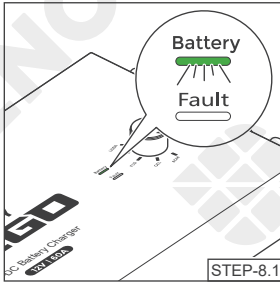

The Battery indicator flashes green while the service battery system is being charged.

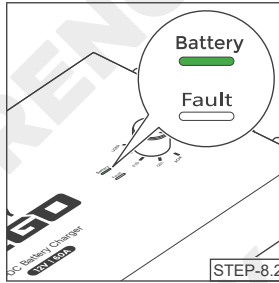

Once the service battery system is fully charged, the battery charger stops working and the Battery indicator lights up green and remains solid.

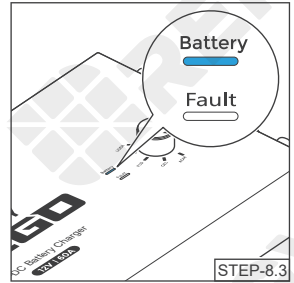

When the power of the starting battery is low, the battery charger will automatically reverse charge the starting battery from the service battery system, and the Battery indicator lights up blue and remains solid.

Fault Status Indicator

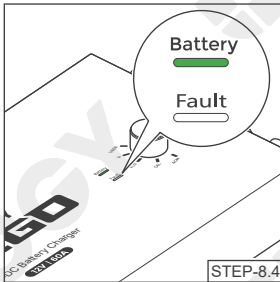

Under normal conditions, the Fault indicator will not light up.

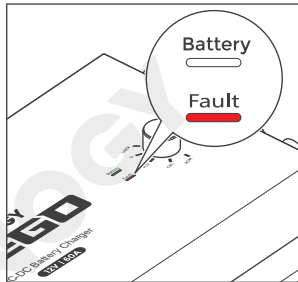

If the Fault indicator lights up, please refer to the user manual of the battery charger at renogy.com for troubleshooting instructions.



Communication

The communication connection is optional. The communication between REGO products allows safe operation, smart control, and close monitoring.

Depending on the installation condition, the communication connection needs to be established with backbone or daisy chain topology.

Backbone Topology

If an RV-C bus is pre-installed in the RV, please follow the backbone topology for the communication connection.

Recommended Accessories

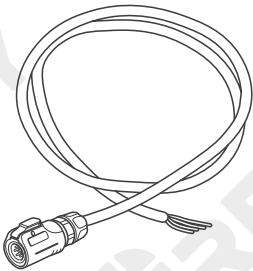
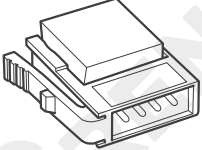
LP16 Plug (7-Pin) to Bare Wires Drop Cable	Drop Plug
	



- Different drop sockets are used on the RV-C bus by different RV manufacturers. Please select the Drop Plug that matches the drop socket for the communication connection. If unsure about the Drop Plug selection, please check with the RV manufacturer. This Quick Guide takes the Mini-Clamp II plug (4-pin) as an example.
- The length of the Drop Cable shall not exceed 19.6 feet, and the total length shall not exceed 98.4 feet.
- Different Drop Plugs follow different pinouts. Please crimp the Drop Plug to the Drop Cable following the correct pinout. If unsure about the Drop Plug pinout, please check with the RV manufacturer. This Quick Guide takes the pinout of the Mini-Clamp II plug (4-Pin) as an example.



Communication

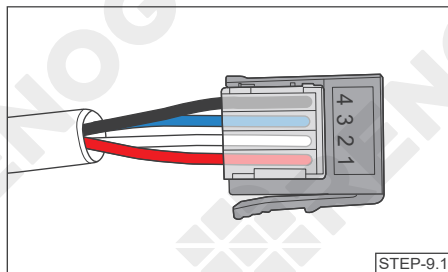

Insert the bare wires of the Drop Cable (sold separately) all the way into the wire ports of the Drop Plug (not included) following the Drop Plug pinout. The red PS+ wire goes to pin 1, the white CAN_H wire goes to pin 2, the blue CAN_L wire goes to pin 3, and the black PS- wire goes to pin 4.

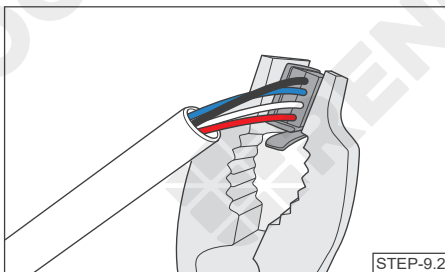

Squeeze the crimp area of the Drop Plug with a pair of split joint pliers.

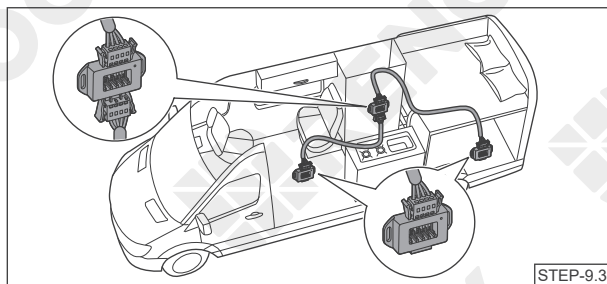

Locate the drop tap (not included) on the RV-C bus (not included) that is the closest to the battery charger installation location. The drop taps are usually located above the entry door, in the bathroom, or under the bed in the RV.

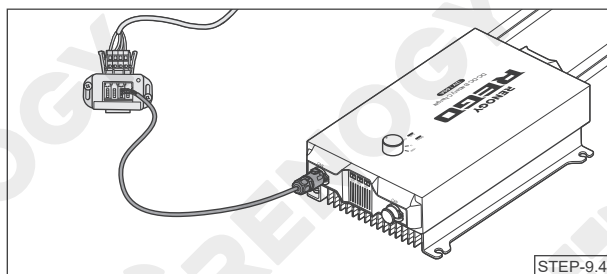

Connect either of the CAN Communication Ports of the battery charger to the drop socket on the drop tap with the Drop Cable.



- Different drop taps are used on the RV-C bus by different RV manufacturers. This Quick Guide takes the 4-socket drop tap as an example.
- If unable to locate the drop taps, please contact the RV manufacturer for help.
- Please ensure termination at both ends of the RV-C bus with 120Ω resistors (not included).



Communication

Daisy Chain Topology

If the RV-C bus is not available, please follow the daisy chain topology for the communication connection.

Recommended Accessories

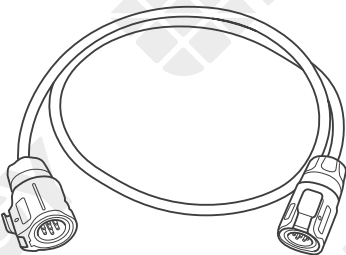
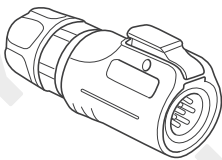
LP16 Plug (7-Pin) Communication Cable	LP16 Terminator Plug (7-Pin)
	

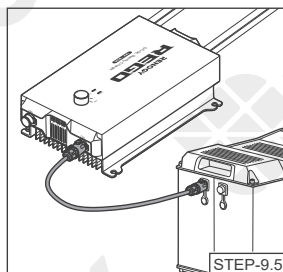

Connect REGO devices in series through either of the CAN Communication Ports with the Communication Cables (sold separately).

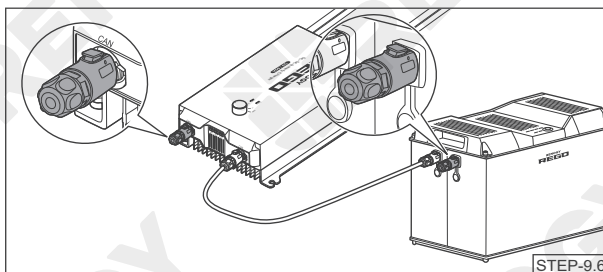

Plug the Terminator Plug (sold separately) into the free CAN Communication Ports on the first and last REGO devices.



Operation & Maintenance

Operation

The battery charger is simple and easy to use. The plug & play design makes the installation easier, and the knob with 5 gears makes the selection of battery type more convenient.

The default battery type of the battery charger is AGM/SLD. After the wiring of the battery charger output is completed, please manually set the battery type according to the usage needs.

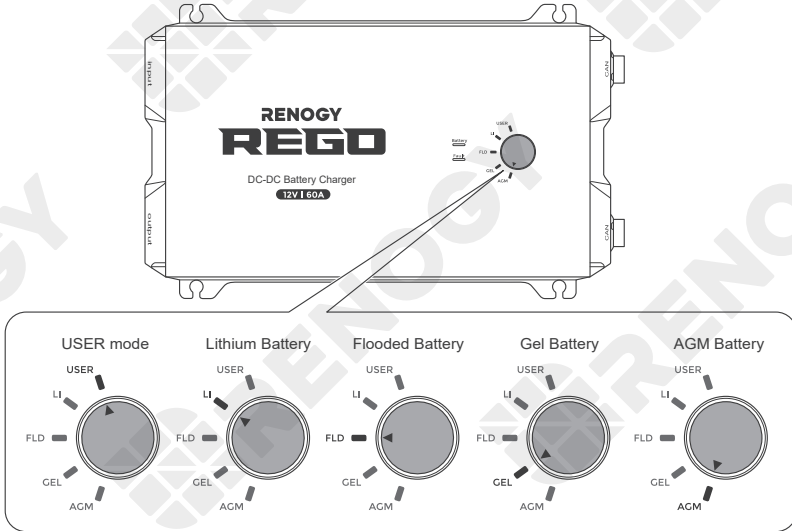

User Mode requires the addition of the Renogy DC Home app customize charge parameters. Please scan the QR Code on the last page of the Quick Guide to download the app.

Maintenance

For optimum performance, it is recommended to perform these tasks regularly.

- Ensure the battery charger is mounted in a clean, dry, and ventilated area.
- Ensure there is no damage or wear on the cables.
- Ensure the firmness of the Anderson connectors and check if there are any loose, damaged or burnt connections.
- Make sure that the Battery indicator and Fault indicator are in normal state.
- Ensure there is no any corrosion, insulation damage, or discoloration marks of overheating or burning.



- Risk of electric shock! Make sure that all power is turned off before touching the terminals on the battery charger.
- Please refer to the user manual of the battery charger at renogy.com for more details.



Renogy Empowered

Renogy aims to empower people around the world through education and distribution of DIYfriendly renewable energy solutions.

We intend to be a driving force for sustainable living and energy independence.

In support of this effort, our range of solar products makes it possible for you to minimize your carbon footprint by reducing the need for grid power.



Live Sustainably with Renogy

Did you know? In a given month, a 1KW solar energy system will...



Save 170 pounds of coal from being burned



Save 300 pounds of CO₂ from being released into the atmosphere



Save 105 gallons of water from being consumed



Renogy Power **PLUS**

Renogy Power Plus allows you to stay in the loop with upcoming solar energy innovations, share your experiences with your solar energy journey, and connect with like-minded people who are changing the world in the Renogy Power Plus community.

Your voice matters! Scan the QR code to submit your feedback on the product.



Welcome to join Renogy Power **PLUS** Community by scanning the QR code to install DC Home App. Find your e-warranty here, and more.

