

COTEK

CR-10

Remote Control User's Manual

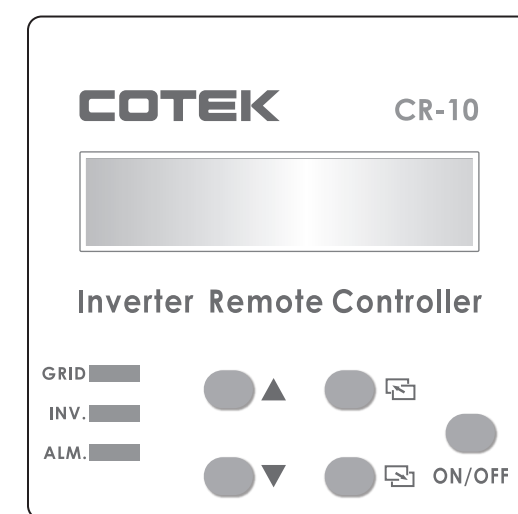

www.cotek.com.tw

Remote control introduction

- Press the ON / OFF button on the front. The SD-series starts working normally. After switching on expect a five to ten second delay. The SD-series will be operating in normal condition when either of the following messages are displayed on the LCD panel screen :

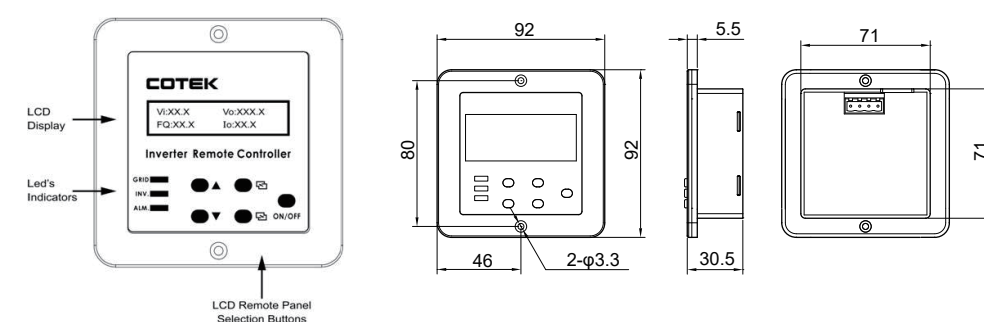

LED Indications :

• GRID: Displays incoming AC input status.

AC Input	LED Status
AC input ON	Green
AC input OFF	OFF

• Inverter: Displays the SD-series working statuses.

DC-AC Inverter	LED Status
Inverter AC Working	Green
Inverter AC Saving	Green Blink
Inverter AC shunt down	OFF

• Alarm: Displays the SD-series alarm status.

Alarm	LED Status
Abnormal	Red
Normal	OFF

- LCD Remote Control Panel Selection Buttons :
- Function :

Function	Description
[Up]	You can use the "up" button to scroll through the menus or to select the value for set up under setting mode.
[Down]	You can use the "Down" button to scroll through the menus or to select the value for set up under setting mode.
[Page Up]	You can use the "Page Up" button to scroll through the menus.
[Page Down]	You can use the "Page Down" button to scroll through the menus.
[Enter Setup Menu]	Press the button longer than 3 seconds. The SD-series will change to "Select Menu" which appears on the LCD screen for the user to set functions.
[Enter]	Confirms a selection or value.
[ON / OFF]	The SD-series can be activated by the button. Press "ON / OFF" button, the SD-series to startup. If you want to turn OFF the SD-series, press the "ON / OFF" button longer than 3 seconds.

LCD Rear View Introduction

- Jump (reference ①)
- The "J1 jump" is placed inside the remote controller.

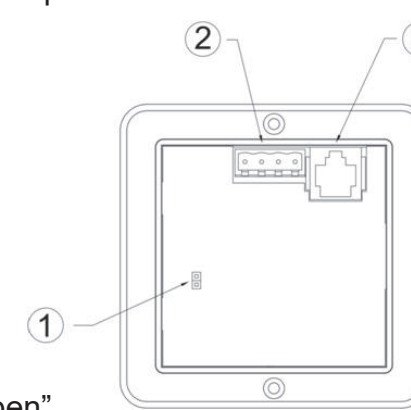

• J1 jump "open"

J1 Jump	"CTL" Input Voltage	SD-series
Open	5 ~ 60 VDC	Turn ON
	0 V	Turn OFF

• J1 jump "short"

J1 Jump	"CTL" Input Voltage	SD-series
Short	5 ~ 60 VDC	Turn ON
	0 V	Turn OFF

Note: The "J1" jump default mode is "short".

- Green Terminal (reference ②)

PIN	Function
1	ALM
2	CTL
3	-ENB
4	-VCC

- ALM (PIN1)
- When the SD-series has the warning or the protection displayed, simultaneously this "ALM" pin will changing output to 5 Volt / 10mA control signal to provide the user.

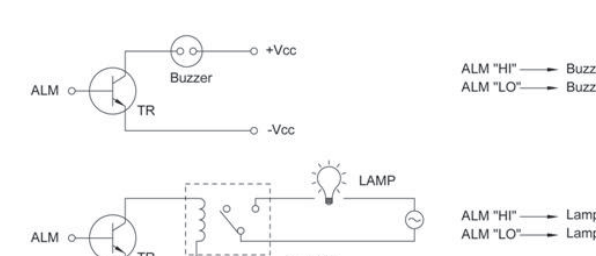

- ENB (PIN3)
- User can USE this "-ENB" pin to control the SD-series to turn ON or turn OFF.

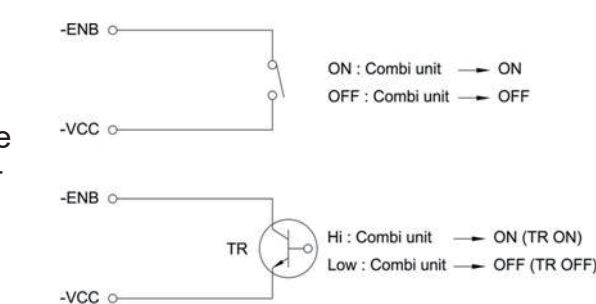

WARNING!
To turn "ON" the SD-series by operating the -ENB function of LCD Panel, the SD-series inverter cannot be turned OFF by any other operations, only by the MAIN "OFF" SWITCH.

- Vcc (PIN4)
- This is LCD remote control panel ground.



ALM-Battery is common ground.

- RJ-45 port, connect to inverter(reference ③)

Display tree:

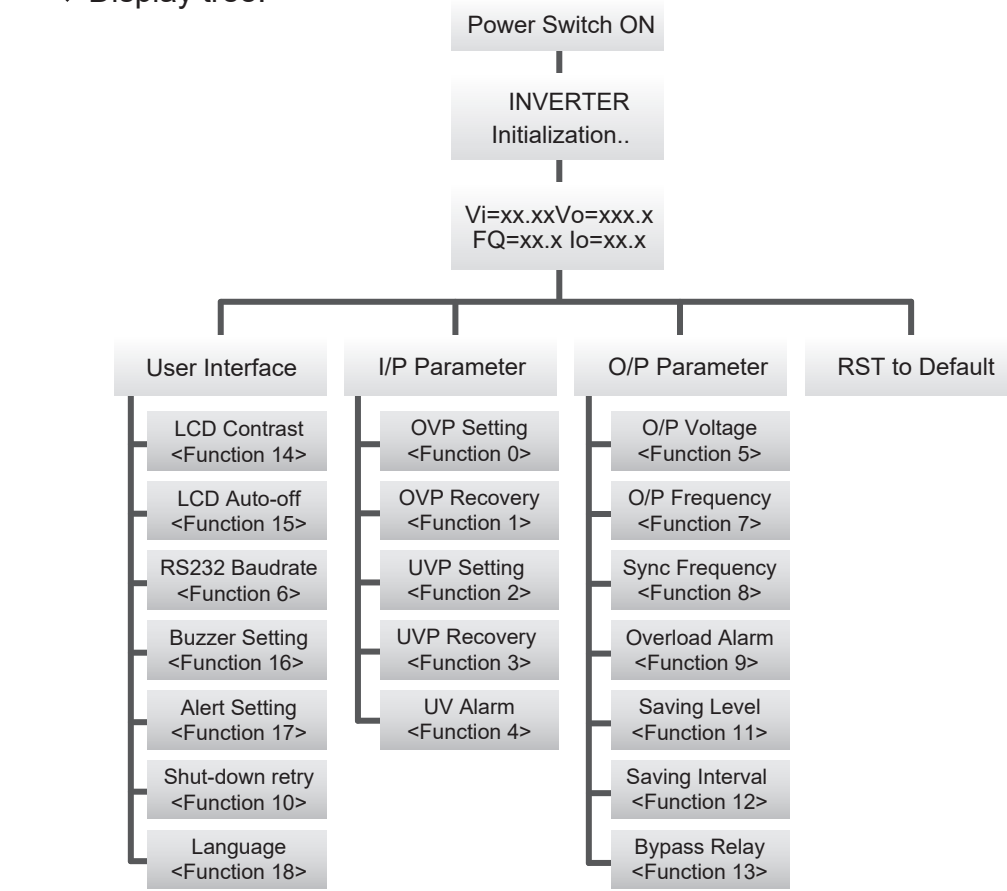

Operation and Instructions Entering Setup Menu:

- Press **ON** button longer than 3 seconds. The SD-series enters the select Menu consisting of four layers:
- (1) User Interface: (2)I/P Parameter: (3) O/P Parameter: (4)RST to Default:
- Select Menu Heading:
The manual is used to show the status of the running SD-series. The user can make selections by switching on **UP** or **DOWN**.

V_iXXX V_oXXXX
F_qXXX I_oXXX
F_q = xx.x →Display the INV frequency.
I_o = xx.x →Display the INV output current.
F_q = xx.x →Display the INV frequency.
I_o = xx.x →Display the INV output current.

- Parameter Setting:
Press **ON** button before entering the "User Interface" menus.

User Interface

- LCD contrast : Sets the LCD screen contrast. Default = 50%
Setting range = 0% ~ 100%

Setting Menu	SETT<value>
LCD Contrast	0 ~ 100

- LCD Auto-off : Sets the LCD screen backlight auto off timer. Default = 120 seconds
Setting range = 0 ~ 120 seconds.

Setting Menu	SETT<value>
LCD Auto-off	0 ~ 120

- RS-232 Baud rate :

Default setting: 4800

Setting Menu	SETT<value>
RS-232 Baud rate	0 1200 1 2400 2 4800 3 9600 4 19200

- Buzzer setting : Set the LCD remote control for the buzzer sound
Default = MSG, Alert, SHDN
Setting range = 0~7

Setting Menu	SETT (RS-232)	Buzzer(Beep sound)
Buzzer Setting	0	Disable
	1	SHDN
	2	Alert
	3	Alert , SHDN
	4	MSG
	5	MSG , SHDN
	6	MSG , Alert
7	MSG , Alert , SHDN	

- Alert Setting : When alert occurs, the internal dry contact relay will open/close.
Default = Alert, SHDN
Setting range = 0~3

Setting Menu	SETT (RS-232)	Alert (LCD)
RS-232 Baud rate	0	Disable
	1	SHDN
	2	Alert
3	Alert , SHDN	

- Shut-down retry : When SD-series is shut-down under OVP, UVP, Overload or short circuit conditions, the inverter will automatically try to restart according to the setting value.
Default = 5
Setting range: 0 ~ 15

- Language : The SD-series have different languages available and are selectable.
Default = English
Setting: English / Italian / Spanish / French / German

Model	SETT (RS-232)
English	0
Italian	1
Spanish	2
French	3
German	4

I/P Parameter

- OVP Setting : Set the Over Voltage Protection (OVP) and shutdown. Default = 16 VDC @ 12V Model, 32 VDC @ 24V Model. 64 VDC @ 48V Model

Model	Setting value range
12V	15 VDC ~ 16 VDC
24V	30 VDC ~ 32 VDC
48V	60 VDC ~ 64 VDC

- OVP Recovery : When the DC input voltage is higher than the OVP setting, the SD-series shuts-down; once the input voltage falls below the set OVP value, the SD-series will automatically restart. Default = 15 VDC @ 12V Model, 30 VDC @ 24V Model. 60 VDC @ 48V Model

Model	Setting value range
12V	13 VDC ~ 15 VDC
24V	26 VDC ~ 30 VDC
48V	52 VDC ~ 60 VDC

- UVP Setting : Setting Under Voltage Protection (UVP) and Shut-down on the inverter operation. Default = 10 VDC @ 12V Model, 20 VDC @ 24V Model. 40VDC @ 48V Model

Model	Setting value range
12V	10 VDC ~ 12.5 VDC
24V	20 VDC ~ 25VDC
48V	40 VDC ~ 50 VDC

- UVP Recovery : When the DC input voltage is below the set UVP value, the SD-series shuts-down; Once the input voltage rises above the set UVP value, the SD-series will automatically restart. Default = 12.5VDC @ 12V Model, 25 VDC @ 24V Model. 50VDC @ 48V Model

Model	Setting value range
12V	11.5 VDC ~ 13.5 VDC
24V	23 VDC ~ 27 VDC
48V	46 VDC ~ 54 VDC

- UV Alarm : Setting Under Voltage (UV) alarm. When the input voltage is lower than the set value, the SD-series will sound a "beep" to remind you that the unit is going to shut-down. In the meantime, the contact in the internal Dry Contact Relay will open / close. Default= 10.5 VDC @ 12 V Model, 21 VDC @ 24 V Model. 42 VDC @ 48 V Model

Model	Setting value range
12V	10.5 VDC ~ 13 VDC
24V	21 VDC ~ 26 VDC
48V	42 VDC ~ 52 VDC

NOTE:

The value of the voltage set for the "UV Alarm" should be equal to or higher than the value set for "UVP" or else the unit will shut-down without any audible warning.

O/P Parameter

- O/P Voltage : Setting the SD-series output voltage on the inverter operation. Default= 110 VAC @ 110 V Model, 230 VAC @ 230 V Model

Model	Setting value range
110V	97 VAC ~ 123 VAC
230V	194 VAC ~ 246 VAC

- O/P Frequency : Setting the SD-series output frequency on the inverter operation. Default= 60 Hz @ 110 V Model, 50 Hz @ 230 V Model.

Model	Setting value range
110V	47 Hz ~ 63 Hz
230V	47 Hz ~ 63 Hz

- Sync Frequency : If a generator is distorted. The output waveform (too low frequency) is used as AC source, the allowed frequency window for the incoming AC power can be enlarged.

- Example1: AC input = 230 VAC / 50Hz, User setting Value= 7Hz
When the SD-series "Output frequency" is within The Range of 43 Hz~57 Hz, the internal transfer relay will close. When the output frequency is less than 43 Hz or more than 57 Hz, the internal transfer relay will still open.

- Example2: When user setting value= Disable, the SD-series "Output frequency" is within the range of 47 Hz~63 Hz, the internal transfer relay will close.
Default= 7Hz

- Overload Alarm : Set the overload alarm. When the SD-series output power is higher than the set value, the SD-series will sound a "beep" to remind you that the unit is going to shut-down. At the same time, the internal Dry Contact Relay will open/close. Default= 102%
Setting range= 50%~110%

- Saving Level : Setting the SD-series to power saving to reduce consumption from the batteries. Default = 0
Setting range = 3 ~ 7

Setting Value	Status
0	Default
3	4%
4	5%
5	6%
6	7%
7	8%

- Saving Interval : When SD-series inverter enters power saving mode, it will detect AC Load periodically. Default = 2.0 Seconds
Setting range = 1.0S ~ 2.0S
If the AC Load is 3 times higher than Saving Level, inverter will recover and output normally to AC Load.

- Bypass Relay : The setup is provided in one of the following two ways.
On-line Mode or Off-line Mode (Exacting, Normal, Haphazard). Default= Normal (Off line).

Model	SETT <value>	Setting value range
Haphazard	0	The transfer relay will switch "ON" or "OFF". Conformance to, phase and frequency synchronization will not be considered.
Normal	1	The transfer relay will be "ON" if AC input (Grid) power is available. The DC-AC inverter will remain synchronized and Phase with the incoming AC power (Grid). The relay will NOT switch off if the grid frequency is beyond the range set under Sync Frequency window.
Exacting	2	The transfer relay will switch "ON" or "OFF" based on conformance to, the Phase and Sync Frequency.
On-line	3	Always supplied by battery until which has run down (UVP) then switch to grid.

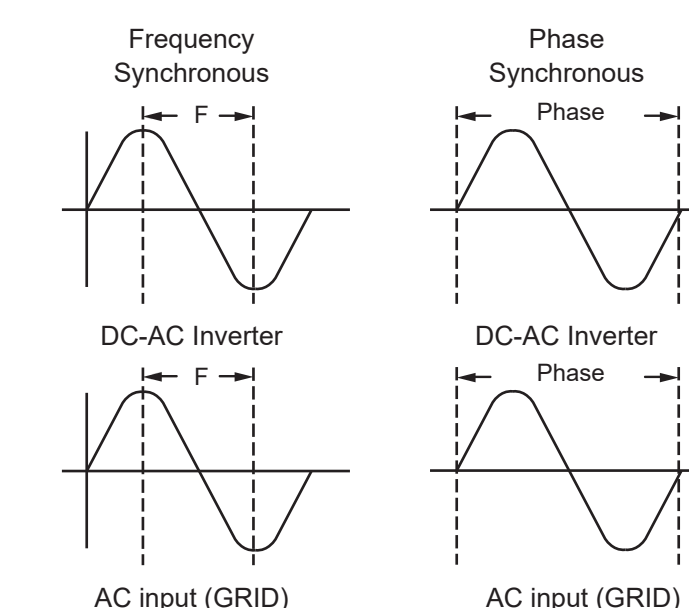

尺寸/印刷：891mm x 210mm，每頁均為A5 size/雙面印刷

摺頁方式：M字摺，如右圖

