

ROVER SERIES

Maximum Power Point Tracking Solar Charge Controller

Rover 60A



Version 1.4



Important Safety Instructions

Please save these instructions.

This manual contains important safety, installation, and operating instructions for the charge controller. The following symbols are used throughout the manual to indicate potentially dangerous conditions or important safety information.

- | | |
|--|--|
|  WARNING | Indicates a potentially dangerous condition. Use extreme caution when performing this task |
|  CAUTION | Indicates a critical procedure for safe and proper operation of the controller |
|  NOTE | Indicates a procedure or function that is important to the safe and proper operation of the controller |

General Safety Information

- Read all of the instructions and cautions in the manual before beginning the installation.
- There are no serviceable parts for this controller. Do **NOT** disassemble or attempt to repair the controller.
- Do **NOT** allow water to enter the controller.
- Make sure all connections going into and from the controller are tight.

Charge Controller Safety

- **NEVER** connect the solar panel array to the controller without a battery. Battery must be connected first.
- Ensure input voltage does not exceed 150 VDC to prevent permanent damage. Use the Open Circuit Voltage (Voc) to make sure the voltage does not exceed this value when connecting panels together.

Battery Safety

- Use only sealed lead-acid, flooded, gel or lithium batteries which **must be deep cycle**.
- Explosive battery gases may be present while charging. Be certain there is enough ventilation to release the gases.
- Be careful when working with large lead acid batteries. Wear eye protection and have fresh water available in case there is contact with the battery acid.
- Carefully read battery manuals before operation.
- Do **NOT** let the positive (+) and negative (-) terminals of the battery touch each other.
- Recycle battery when it is replaced.
- Over-charging and excessive gas precipitation may damage the battery plates and activate material shedding on them. Too high of an equalizing charge or too long of one may cause damage. Please carefully review the specific requirements of the battery used in the system.
- Equalization is carried out only for non-sealed / vented/ flooded / wet cell lead acid batteries.
- Do **NOT** equalize VRLA type AGM / Gel / Lithium cell batteries UNLESS permitted by battery manufacturer.

WARNING

Connect battery terminals to the charge controller **BEFORE** connecting the solar panel(s) to the charge controller. **NEVER** connect solar panels to charge controller until the battery is connected.

Do **NOT** connect any inverters or battery charger into the load terminal of the charge controller.

Once equalization is active in the battery charging, it will not exit this stage unless there is adequate charging current from the solar panel. There should be **NO** load on the batteries when in equalization charging stage.

Table of Contents

General Information	04
Additional Components	08
Optional Components	08
Identification of Parts	09
Installation	10
Operation	19
LED Indicators	27
Rover Protections	29
System Status Troubleshooting	30
Maintenance	30
Fusing	31
Technical Specifications	31
Electrical Parameters	31
General	32
Battery Charging Parameters	32
PV Power – Conversion Efficiency Curves	33
Dimensions	34

General Information

The Rover Series charge controllers are intelligent controllers suitable for various off-grid solar applications. It protects the battery from being over-charged by the solar modules and over-discharged by the loads. The controller features a smart tracking algorithm that maximizes the energy from the solar PV module(s) and charge the battery. At the same time, the low voltage disconnect function (LVD) will prevent the battery from over discharging.

The Rover's charging process has been optimized for long battery life and improved system performance. The comprehensive self-diagnostics and electronic protection functions can prevent damage from installation mistakes or system faults.

Key Features

- Automatically detect 12V/24V/36V/48V DC system voltages
- Innovative MPPT technology with high tracking efficiency up to 99% and peak conversion efficiency of 98%
- Deep cycle Sealed, Gel, Flooded and Lithium battery option ready
- Electronic protection: Overcharging, over-discharging, overload, and short circuit
- Reverse protection: Any combination of solar module and battery, without causing damage to any component
- Customizable charging voltages
- RS232 port to communicate with BT-1 Bluetooth Module or DM-1 4G Data Module
- Charges over discharged lithium batteries
- ETL Listed to UL1741 and CSA C22.2

MPPT Technology

The MPPT Charge Controller utilizes Maximum Power Point Tracking technology to extract maximum power from the solar module(s). The tracking algorithm is fully automatic and does not require user adjustment. MPPT technology will track the array's maximum power point voltage (Vmp) as it varies with weather conditions, ensuring that the maximum power is harvested from the array throughout the course of the day.

Current Boost

In many cases, the MPPT charge controller will "boost" up the current in the solar system. The current does not come out of thin air. Instead, the power generated in the solar panels is the same power that is transmitted into the battery bank. Power is the product of Voltage (V) x Amperage (A).

Therefore, assuming 100% efficiency:

$$\begin{aligned} \text{Power In} &= \text{Power Out} \\ \text{Volts In} * \text{Amps In} &= \text{Volts out} * \text{Amps out} \end{aligned}$$

Although MPPT controllers are not 100% efficient, they are very close at about 92-95% efficient. Therefore, when the user has a solar system whose V_{mp} is greater than the battery bank voltage, then that potential difference is proportional to the current boost. The voltage generated at the solar module needs to be stepped down to a rate that could charge the battery in a stable fashion by which the amperage is boosted accordingly to the drop. It is entirely possible to have a solar module generate 8 amps going into the charge controller and likewise have the charge controller send 10 amps to the battery bank. This is the essence of the MPPT charge controllers and their advantage over traditional charge controllers. In traditional charge controllers, that stepped down voltage amount is wasted because the controller algorithm can only dissipate it as heat. The following demonstrates a graphical point regarding the output of MPPT technology.

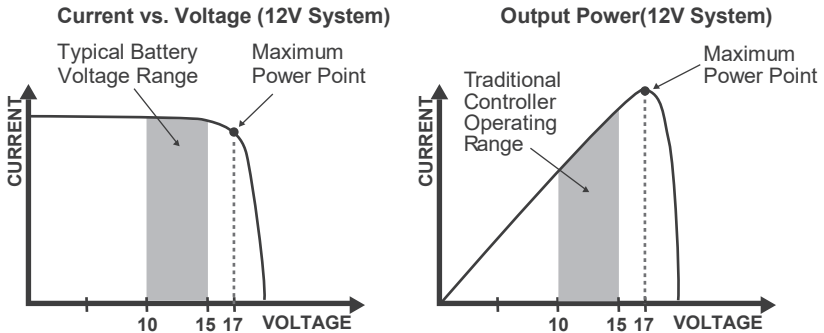

Limiting Effectiveness

Temperature is a huge enemy of solar modules. As the environmental temperature increases, the operating voltage (V_{mp}) is reduced and limits the power generation of the solar module. Despite the effectiveness of MPPT technology, the charging algorithm will possibly not have much to work with and therefore there is an inevitable decrease in performance. In this scenario, it would be preferred to have modules with higher nominal voltage, so that despite the drop in performance of the panel, the battery is still receiving a current boost because of the proportional drop in module voltage.

Four Charging Stages

The Rover MPPT charge controller has a 4-stage battery charging algorithm for a rapid, efficient, and safe battery charging. They include: Bulk Charge, Boost Charge, Float Charge, and Equalization.

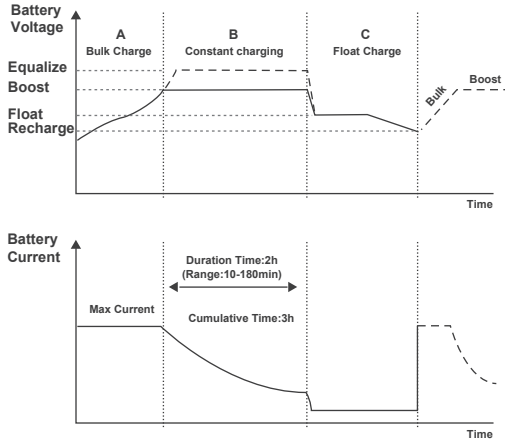

Bulk Charge: This algorithm is used for day to day charging. It uses 100% of available solar power to recharge the battery and is equivalent to constant current. In this stage the battery voltage has not yet reached constant voltage (Equalize or Boost), the controller operates in constant current mode, delivering its maximum current to the batteries (MPPT Charging) .

Constant Charging: When the battery reaches the constant voltage set point, the controller will start to operate in constant charging mode, where it is no longer MPPT charging. The current will drop gradually. This has two stages, equalize and boost and they are not carried out constantly in a full charge process to avoid too much gas precipitation or overheating of the battery.

- **Boost Charge:** Boost stage maintains a charge for 2 hours by default. The user can adjust the constant time and preset value of boost per their demand.

Float Charge: After the constant voltage stage, the controller will reduce the battery voltage to a float voltage set point. Once the battery is fully charged, there will be no more chemical reactions and all the charge current would turn into heat or gas. Because of this,

The charge controller will reduce the voltage charge to smaller quantity, while lightly charging the battery. The purpose for this is to offset the power consumption while maintaining a full battery storage capacity. In the event that a load drawn from the battery exceeds the charge current, the controller will no longer be able to maintain the battery to a Float set point and the controller will end the float charge stage and refer back to bulk charging.

⚠ Equalization: Is carried out every 28 days of the month. It is intentional overcharging of the battery for a controlled period of time. Certain types of batteries benefit from periodic equalizing charge, which can stir the electrolyte, balance battery voltage and complete chemical reaction. Equalizing charge increases the battery voltage, higher than the standard complement voltage, which gasifies the battery electrolyte.

WARNING

Once equalization is active in the battery charging, it will not exit this stage unless there is adequate charging current from the solar panel. There should be NO load on the batteries when in equalization charging stage.

WARNING

Over-charging and excessive gas precipitation may damage the battery plates and activate material shedding on them. Too high of equalizing charge or for too long may cause damage. Please carefully review the specific requirements of the battery used in the system.

WARNING

Equalization may increase battery voltage to a level damaging to sensitive DC loads. Ensure that all load allowable input voltages are greater than the equalizing charging set point voltage.

Lithium Battery Activation

The Rover MPPT charge controller has a reactivation feature to awaken a sleeping lithium battery. The protection circuit of lithium battery will typically turn the battery off and make it unusable if over-discharged. This can happen when storing a lithium battery pack in a discharged state for any length of time as self-discharge would gradually deplete the remaining charge. Without the wake-up feature to reactivate and recharge batteries, these batteries would become unserviceable and the packs would be discarded. The Rover will apply a small charge current to activate the protection circuit and if a correct cell voltage can be reached, it starts a normal charge.

Additional Components

Additional components included in the package:



Remote Temperature Sensor:

This sensor measures the temperature at the battery and uses this data for very accurate temperature compensation. The sensor is supplied with a 9.8ft cable length that connects to the charge controller. Simply connect the cable and adhere the sensor on top or the side of the battery to record ambient temperature around the battery.

NOTE

Do Not use this sensor when charging lithium battery.



Mounting Brackets:

These brackets can be used to mount the Rover charge controller on any flat surface. The screws to mount the brackets to the charge controller are included, screws to mount charge controller to surface are not included.

Mounting Oval: 7.66 x 4.70mm(0.30 x 0.18in)

Optional Components

Optional components that require a separate purchase:



Renogy BT-1 Bluetooth Module:

The BT-1 Bluetooth module is a great addition to any Renogy charge controllers with a RS232 port and is used to pair charge controllers with the Renogy BT App. After pairing is done you can monitor your system and change parameters directly from you cell phone or tablet. No more wondering how your system is performing, now you can see performance in real time without the need of checking on the controller's LCD.



Renogy DM-1 4G Data Module:

The DM-1 4G Module is capable of connecting to select Renogy charge controllers through an RS232, and is used to pair charge controllers with Renogy 4G monitoring app. This app allows you to conveniently monitor your system and charge system parameters remotely from anywhere 4G LTE network service is available.

Identification of Parts

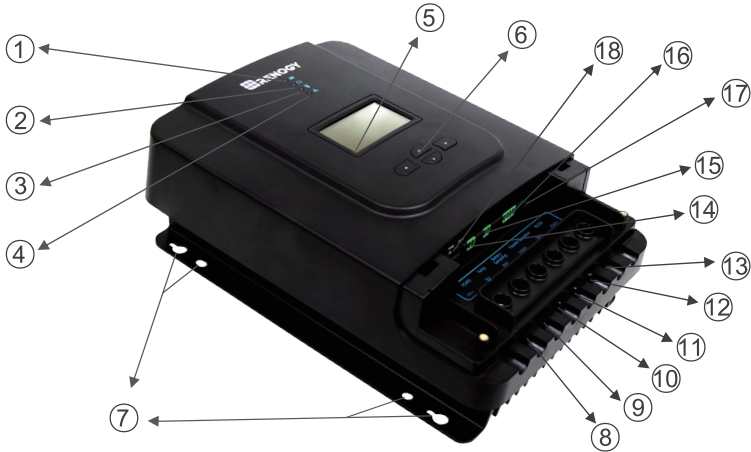

Key Parts

- | | |
|------------------------------|---|
| 1. Charging Indicator | 10. Battery “-” Interface |
| 2. Battery Indicator | 11. Load “-” Interface |
| 3. Load Indicator | 12. Battery “+” Interface |
| 4. Abnormality Indicator | 13. Load “+” Interface |
| 5. LCD Screen | 14. External Temperature Sampling Interface |
| 6. Operating Keys | 15. Battery Voltage Compensation Interface |
| 7. Installation Hole | 16. Controller Parallel Port |
| 8. Solar panel “+” Interface | 17. RS232 Communication Interface |
| 9. Solar panel “-” Interface | 18. RS485 Communication Interface |

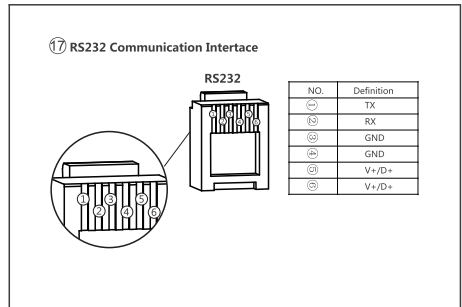
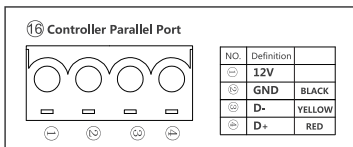
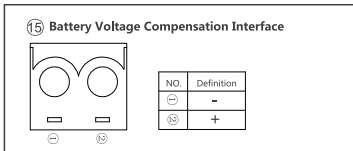

Installation

Recommended tools to have before installation:

Screwdriver	Multi-Meter
	

WARNING

Connect battery terminal wires to the charge controller **FIRST** then connect the solar panel(s) to the charge controller. **NEVER** connect solar panel to charge controller before the battery.

WARNING

Do **NOT** connect any inverters or battery chargers into the **LOAD TERMINAL** of the charge controller.

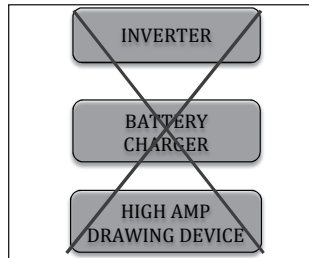

CAUTION

Do not over tighten the screw terminals. This could potentially break the piece that holds the wire to the charge controller.

CAUTION

Refer to the technical specifications for max wire sizes on the controller and for the maximum amperage going through wires.

Remove Cover

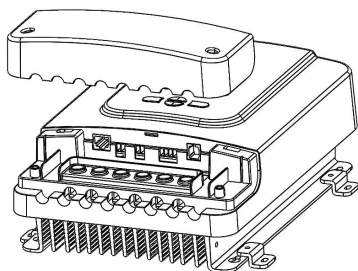
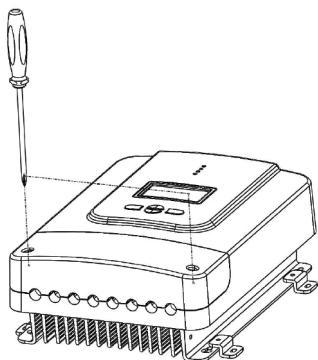

Battery

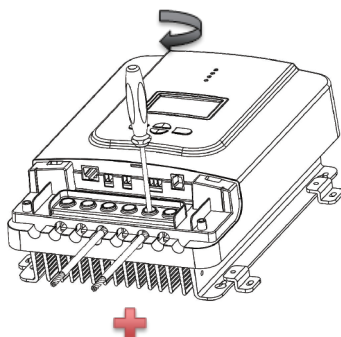
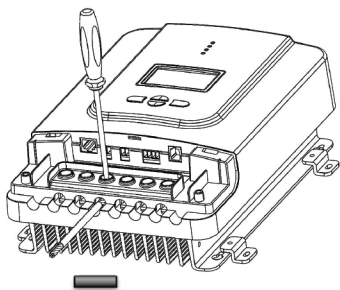

■ Solar Panels

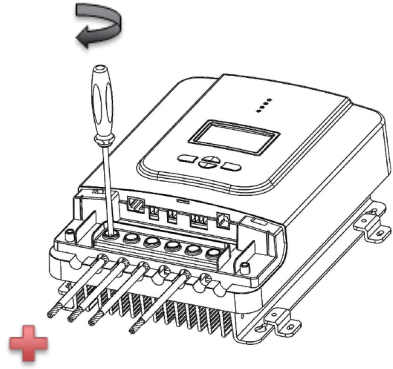
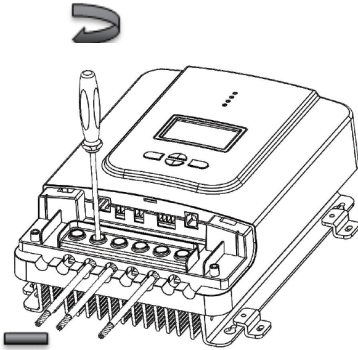

■ Load (optional)

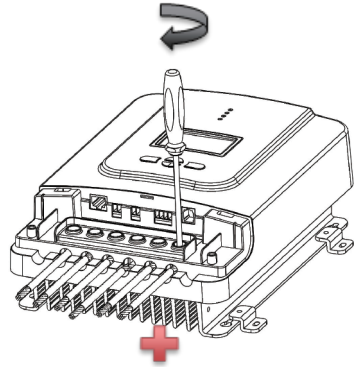
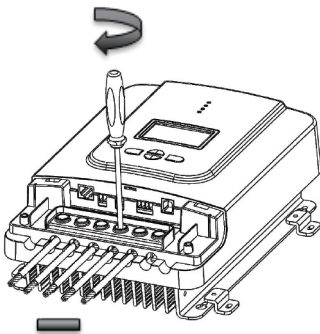

Bluetooth Module Communication (optional)

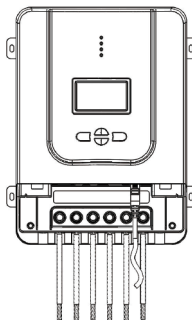
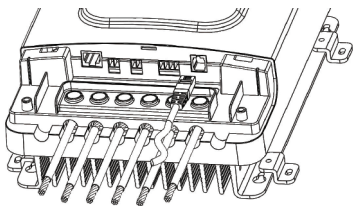

Temperature Sensor (optional, not polarity sensitive)

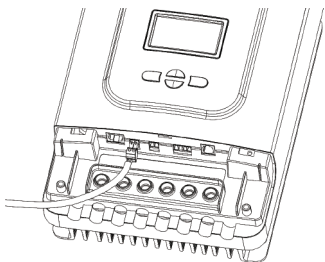

Place the sensor close to the battery

Install Cover

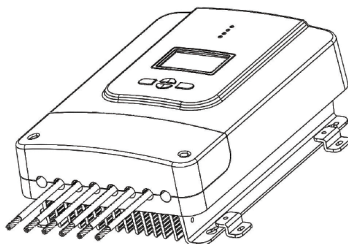
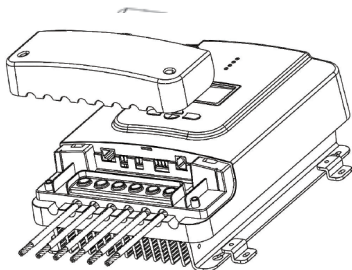

Mounting Recommendations

WARNING

NEVER install the controller in a sealed enclosure with flooded batteries. Gas can accumulate and there is a risk of explosion.

- 1. Choose Mounting Location**—place the controller on a vertical surface protected from direct sunlight, high temperatures, and water. Make sure there is good ventilation.
- 2. Check for Clearance**—verify that there is sufficient room to run wires, as well as clearance above and below the controller for ventilation. The clearance should be at least 3 inches (75mm).
- 3. Mark Holes**
- 4. Drill Holes**
- 5. Secure the charge controller.**

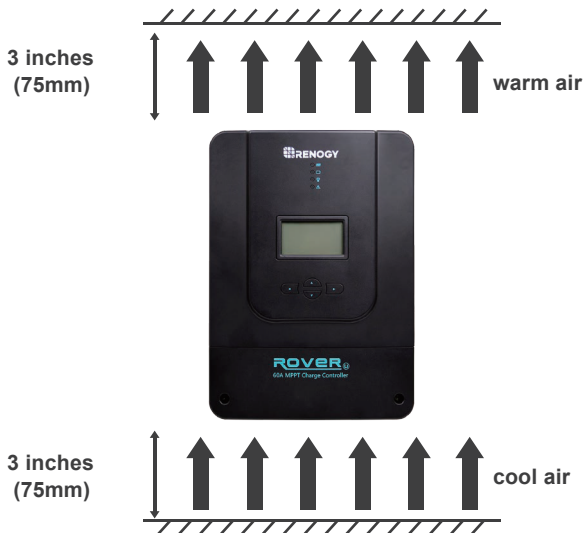

Mounting Recommendations

The controller can be mounted using the existing mounting holes or using the included mounting brackets.

Using Mounting Holes

Step 1.

Measure the distance between each mounting hole on the Rover. Using that distance drill 4 screws onto desired surface.

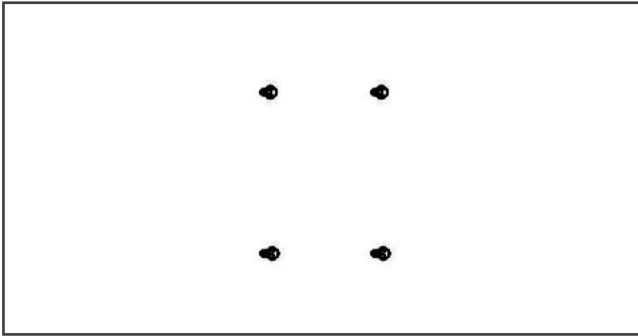

Step 2.

Align the Rovers mounting holes with the screws

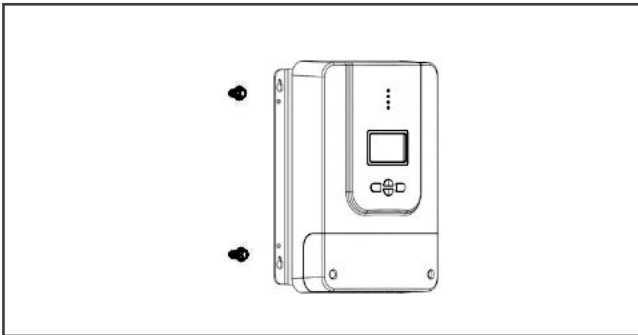

Step 3.

Verify all screw heads are inside the mounting holes. Release controller and check if mounting feels secure

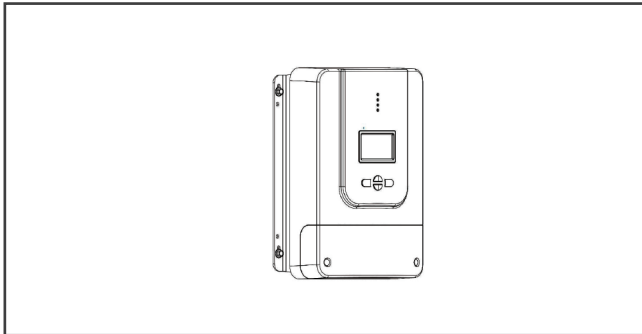
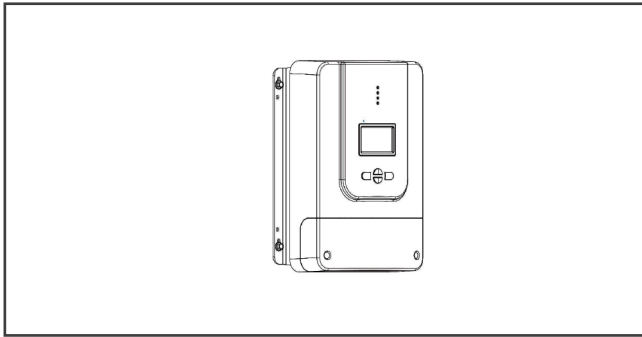

Using Mounting Brackets

Step 1.

Install the brackets using the provided components

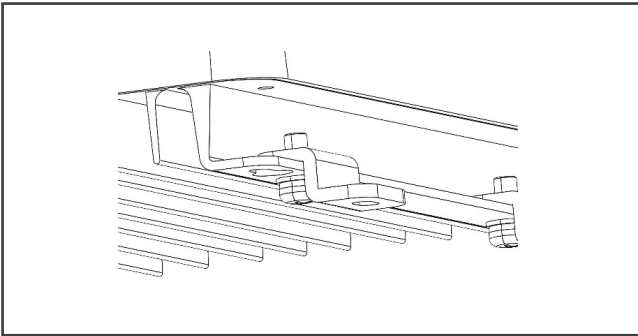
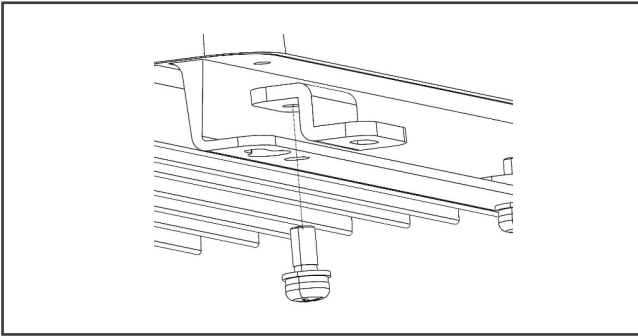

Step 2.

Align the mounting brackets to desired surface and use the appropriate screws to drill into surface(screws not included)

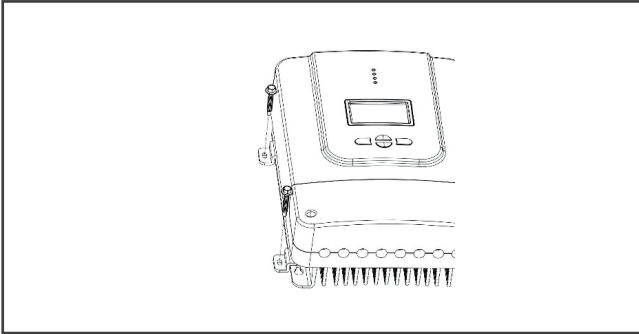

Step 3.

Verify mounting is secure

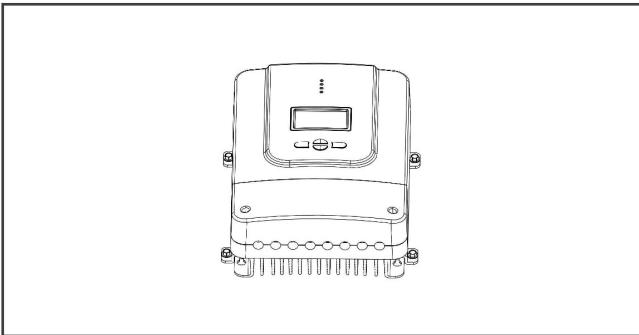

Operation

Rover is very simple to use. Simply connect the batteries, and the controller will automatically determine the battery voltage. The controller comes equipped with an LCD screen and 4 buttons to maneuver through the menus.

Main Display

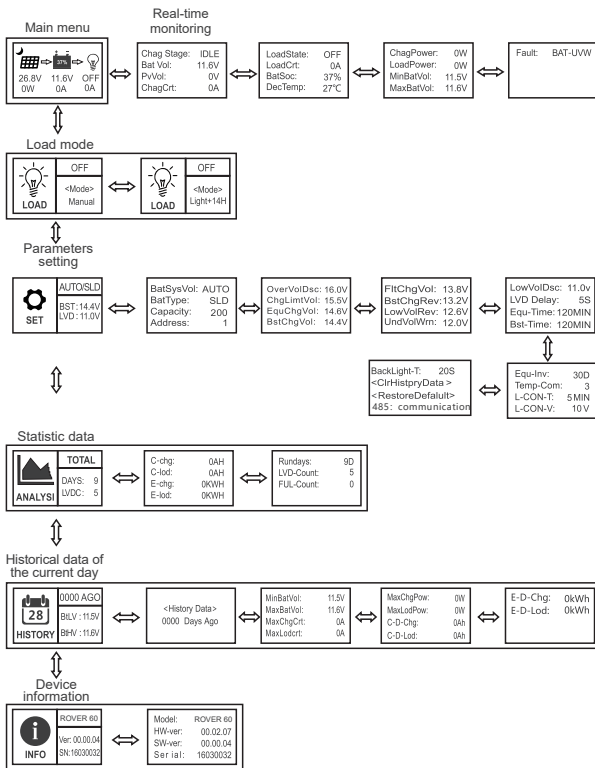

NOTE



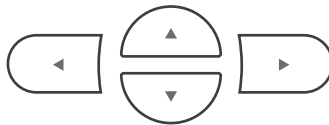
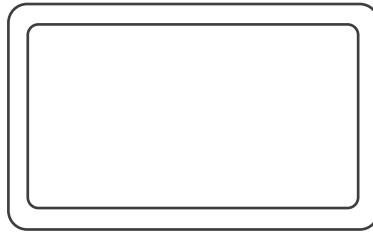

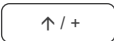
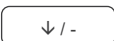
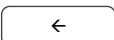

The Battery Capacity (SOC%) is an estimation based on the charging voltage.

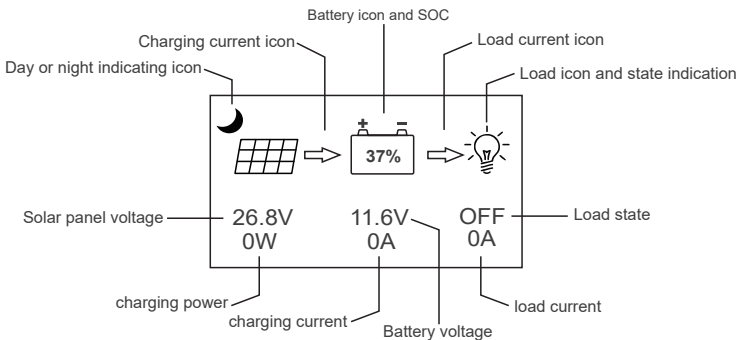

	Page Up/ Increase parameter value
	Page Down/ Decrease parameter value
	Return to the previous menu

Main Menu



Icon or Value	State	Description
	Steady on	Nighttime
	Steady on	Daytime
	Steady on	A dynamic arrow indicates charging is in progress.
	0-100%	Current battery capacity
	0% Slow Flashing	Battery over-discharged
	100% Flash Flashing	Battery over-voltage
	Steady on	Load Terminal in on
	Steady on	Load Terminal is off
	Fast Flashing	Overload or short-circuit protection

Real-Time Monitoring

To view this screen in the main menu, tap the Right arrow button. To change between screens, press the up or down buttons. To return to the main menu screen press the left arrow button.

Screen	Displayed Item/Parameter	Description
1	Chag State: Idle	Charging State Indicators: "Idle", no charging "MPPT", MPPT charging "EQU", Equalization charging "BST", Boost charging "FLT", Float charging "LIMIT", current-limited charging
	BatVol: 11.6V	Battery Voltage
	PvVol: 0V	Solar Panel Voltage
	ChagCrt	Charging Current
2	LoadState: OFF	Load in "ON" or "OFF"
	LoadCrt: 0A	Load current
	BatSoc: 100%	Remaining battery capacity
	Dev Temp: 27°C	Controller Temperature
3	ChagPower: 0W	Current Wattage
	LoadPower: 0W	Load Wattage
	MinBatVol: 12.5V	The current day's minimum battery voltage
	MaxBatVol: 13.5V	The current day's maximum battery voltage
4	Fault: NULL	Controller Error Codes: "BAT-LDV" over-discharge "BAT-OVD" over-voltage "BAT-UVW" under-voltage warning "L-SHTCRT" load short-circuit "L-OVRCRT" load over-current "DEV-OVRTMP" internal over-temperature "BAT-OVRTMP" battery over-temperature "PV-OVP" solar panel over wattage "PV-OC-OVD" solar panel over-voltage "PV-REV" solar panel reverse-polarity "BAT-REV" battery reverse-polarity

Programming Load Terminal

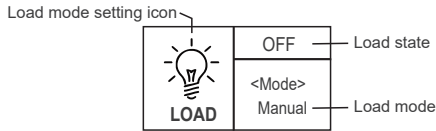

1. If the characters displayed on top of "<Mode>" are "ON", it indicates that the load is switched on
2. Tap " Right Arrow Button" to enter the load setting mode, and right below the "<Mode>", the mode characters or digits will begin to flash. Use " Up and Down Arrow Buttons" to select any one from the load modes listed in the following table and tap " Right Arrow Button" again to complete the load mode setting.
3. Press and hold " Right Arrow Button " in any menu but not the setting mode: if the current load mode is "manual mode", pressing and holding the key will switch on/ off the load; if the current load mode is not "manual mode", pressing and holding the key will cause the display to skip to the load mode setting interface and a reminder will pop up telling the user in this mode, pressing and holding the key will not switch on/ off the load.

Load Mode Options

Load Mode	Mode	Description
Light+ On	Solar Light Control Mode	The load will turn on at night when the solar panel is no longer producing any power after a short time delay. The load will turn off when the panel starts producing power.
Light+ 01H-14H	Time control	When the panel is no longer producing power the load will be ON for 1-14 hours or until the panel starts producing power.
Manual	Manual Mode	In this mode, the user can turn the Load On/Off by pressing the Enter button at any time.
Debug	Test	Used to troubleshoot load terminal (No Time Delay). When voltage is detected load will be off and when no voltage is detected load will be on.
Normal On	24Hr	The load will be on for 24 hours a day.

Parameter Settings

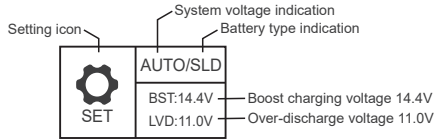

To enter the following settings, in the parameters setting screen press the Right arrow button.

Screen	Parameter	Displayed Parameter	Description
1	Battery system voltage	BatSysVol:	12V/24V/36V/48V, AUTO
	Battery type	BatType:	"SLD" Sealed lead-acid battery "FLD" Flooded lead-acid battery "GEL" Gel battery "Li" Lithium battery "USE" user defined
	Nominal battery capacity	Capacity:	0-9999
	Device address	Address:	1-60
2	Overvoltage threshold	OverVolDsc:	9.0-17.0V
	Charging limit voltage	ChgLimitVol:	9.0-17.0V
	Equalization Voltage	EquChgVol:	9.0-17.0V
	Boost charging voltage	BstChgVol:	9.0-17.0V
3	Float charging voltage	FltChgVol:	9.0-17.0V
	Boost charging recovery voltage	BstChgRev:	9.0-17.0V
	Over-discharge recovery voltage	LowVolRev:	9.0-17.0V
	Under-voltage warning level	UndVolWrn:	9.0-17.0V
4	Low voltage disconnect	LowVolDisc:	9.0-17.0V
	Low voltage disconnect delay	LVD Delay:	0-60s
	Equalization time	Equ-Time:	120Min
	Boost time	Bst-Time:	120Min

5	Equalization charging interval	Equ-Inv:	28DAYS
	Temperature compensation	Temp-Com:	-(3-5) mV/°C/2V
	Light control time	L-CON-T:	0-60 MIN
	Light control voltage	L-CON-V:	5-11V
6	Back light time	BackLight-T	0-600s
	Clear history	<ClrHistoryData>	
	Restore default settings	<RestoreDefault>	
	Communication	485:Communication	

Statistical Data

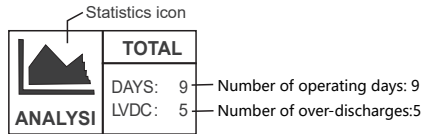

To enter the following settings, in the Statistical Data screen press the Right arrow button.

Battery	Displayed Parameter	Description
1	C-chg: 0AH	Total amp hours produced
	C-lod: 0AH	Total amp hours consumed
	E-chg: 0KWH	Total power generated
	E-lod: 0KWH	Total power consumed
2	Rundays: 10D	Total number of operating days
	LVD-Count: 0	Total number of over-discharges
	FUL-Count: 0	Total number of full-charges

Historical Data

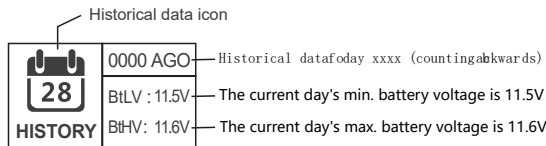

To enter the following settings, in the Historical Data screen press the Right arrow button.

Screen	Displayed Parameter	Description
1	<History Data> xxxx Days Ago	xxxx: select the historical data of day xxxx (counting backwards) 0000: current day 0001: yesterday 0002: the day before yesterday
2	MinBatVol: 11.5V	The selected day's min. battery voltage
	MaxBatVol: 11.6V	The selected day's max. battery voltage
	MaxChgCrt: 0A	The selected day's max. charging current
	MaxLodCrt: 0A	The selected day's max. discharge current
3	MaxChgPow: 0W	The selected day's max. generated power
	MaxLodPow: 0W	The selected day's max. discharged power
	C-D-Chg: 0AH	The selected day's total charged amp hours
	C-D-Lod: 0AH	The selected day's total discharged amp hours
4	E-D-Chg: 0KWh	The selected day's total power generated
	E-D-Lod: 0KWh	The selected day's total power consumed

Device Information

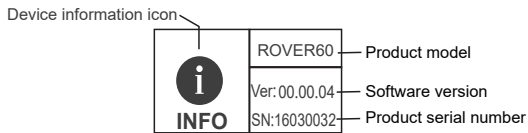







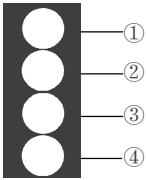







To enter the following settings, in the Device Information screen press the Right arrow button.

Screen	Displayed Parameter	Description
1	Model: ROVER60	Controller model
	HW-ver: 00.02.07	Hardware version
	SW-ver: 00.00.04	Software version
	Serial: 123456789	Controller serial number

LED Indicators

	①---PV array indicator	Indicating the controller's current charging mode.
	②---BAT indicator	Indicating the battery's current state.
	③---LOAD indicator	Indicating the loads' On/ Off state.
	④---ERROR indicator	Indicating whether the controller is functioning normally.

PV Indicator (1)		Status
	White Solid	The PV system is <u>charging</u> the battery bank
	White Slow Flashing	The Controller is undergoing boost stage
	White Single Flashing	The Controller is undergoing float stage
	White Fast Flashing	The Controller is undergoing equalization stage
	White Double Flashing	The oversized PV system is <u>charging</u> the battery bank at the rated current.
	Off	The PV system is <u>not charging</u> the battery bank. PV not detected.
BATT Indicator (2)		Status
	White Solid	Battery is <u>normal</u>
	White Slow Flashing	Battery <u>over-discharged</u>
	White Fast Flashing	Battery <u>over-voltage</u>
LOAD Indicator (3)		Status
	White Solid	Load is <u>on</u>
	White Fast Flashing	Load is <u>over-loaded</u> or <u>short-circuited</u>
	Off	Load is <u>off</u>
ERROR Indicator (4)		Status
	White Solid	System Error. Please check LCD for Error code
	Off	System is operating normally

Rover Protections

Protection	Behavior
PV Array Short Circuit	When PV short circuit occurs, the controller will stop charging. Clear it to resume normal operation.
PV Overcurrent	The controller will limit the battery charging current to the maximum battery current rating. Therefore, an over-sized solar array will not operate at peak power.
Load Overload	If the current exceeds the maximum load current rating of 21A, the controller will disconnect the load. Overloading must be cleared up by reducing the load and restarting the controller.
Load Short Circuit	Fully protected against the load wiring short-circuit. Once the load short (more than quadruple rate current), the load short protection will start automatically. After 5 automatic load reconnect attempts, the faults must be cleared by restarting the controller.
PV Reverse Polarity	The controller will not operate if the PV wires are switched. Wire them correctly to resume normal controller operation.
Battery Reverse Polarity	The controller will not operate if the battery wires are switched. Wire them correctly to resume normal controller operation.
Over-Temperature	If the temperature of the controller heat sink exceeds 65°C, the controller will automatically start reducing the charging current and shut down when temperature exceeds 80°C.

System Status Troubleshooting

PV indicator	Troubleshoot
Off during daylight	Ensure that the PV wires are correctly and tightly secured inside the charge controller PV terminals. Use a multi-meter to make sure the poles are correctly connected to the charge controller.
BATT Indicator	Troubleshoot
White Slow Flashing	Disconnect loads, if any, and let the PV modules charge the battery bank. Use a multi-meter to frequently check on any change in battery voltage to see if condition improves. This should ensure a fast charge. Otherwise, monitor the system and check to see if system improves.
White Fast Flashing	Using a multimeter check the battery voltage and verify it is not exceeding 32 volts.
Load Indicator	Troubleshoot
White Fast Flashing	The Load circuit on the controller is being shorted or overloaded. Please ensure the device is properly connected to the controller and make sure it does not exceed 20A (DC).
Error Indicator	Troubleshoot
WhiteSolid	System Error. Please check LCD for Error code

Maintenance

WARNING

Risk of Electric Shock! Make sure that all power is turned off before touching the terminals on the charge controller.

For best controller performance, it is recommended that these tasks be performed from time to time.

1. Check that controller is mounted in a clean, dry, and ventilated area.
2. Check wiring going into the charge controller and make sure there is no wire damage or wear.
3. Tighten all terminals and inspect any loose, broken, or burnt up connections.
4. Make sure LED readings are consistent. Take necessary corrective action.
5. Check to make sure none of the terminals have any corrosion, insulation damage, high temperature, or any burnt/discoloration marks.

Fusing

Fusing is a recommended in PV systems to provide a safety measure for connections going from panel to controller and controller to battery. Remember to always use the recommended wire gauge size based on the PV system and the controller.

NEC Maximum Current for different Copper Wire Sizes									
AWG	16	14	12	10	8	6	4	2	0
Max. Current	18A	25A	30A	40A	55A	75A	95A	130A	170A

NOTE

The NEC code requires the overcurrent protection shall not exceed 15A for 14AWG, 20A for 12 AWG, and 30A for 10AWG copper wire.

Fuse from Controller to Battery

Controller to Battery Fuse = Current Rating of Charge Controller
Ex. 20A MPPT CC = 20A fuse from Controller to Battery

Fuse from Solar Panel(s) to Controller

Ex. 200W; 2 X 100 W panels

****Utilize 1.56 Sizing Factor (SF)**

NOTE

Different safety factors could be used. The purpose is to oversize.

Series:
Total Amperage= $I_{sc1} = I_{sc2} * SF$
 $= 5.75A * 1.56 = 8.97$
Fuse = 9A fuse

Parallel:
Total Amperage= $(I_{sc1} + I_{sc2}) * SF$
 $= (5.75A + 5.75A) * 1.56 = 17.94$
Fuse = 18A fuse

Technical Specifications

Electrical Parameters

Model	RVR60
Nominal system voltage	12V/24V/36V/48V Auto Recognition
Rated Battery Current	60A
Rated Load Current	20A
Max. capacitive load capacity	10000μF
Battery Voltage	9V - 70V
Max Solar Input Voltage	140 VDC
Max. power point voltage range	Battery voltage +2V to 120V
Max. Solar Input Power	800W/12V;1600W/24V;2400W/36V;3200W/48V
Self-Consumption	0.7W - 1.2W
Conversion efficiency	≤ 98%
MPPT tracking efficiency	> 99%
Temp. Compensation	-3mV/°C/2V (default)

General

Model	RVR60
Dimensions	285 x 205 x 102mm (11.2 x 8.1 x 4.0in)
Mounting Holes	4 x Ø10mm
Max Terminal Size	25mm ² 4 AWG
Net Weight	3.6 kg 7.9 lbs
Working Temperature	-35°C to +45°C
Humidity Range	≤ 95% (NC)
Enclosure	IP32
Altitude	< 3000m
Communication	RS232 RS485
Certifications	ETL Listed to UL1741

Battery Charging Parameters

Battery	GEL	SEALED	FLOODED	LI (LFP)	USER
High Voltage Disconnect	16 V	16 V	16 V	16 V	9-17 V
Equalization Voltage	----	14.6 V	14.8V	----	9-17 V
Boost Voltage	14.2 V	14.4 V	14.6 V	14.4 V	9-17 V
Float Voltage	13.8 V	13.8 V	13.8 V	----	9-17 V
Boost Return Voltage	13.2 V	13.2 V	13.2 V	13.2 V	9-17 V
Low Voltage Reconnect	12.6 V	12.6 V	12.6 V	12.6 V	9-17 V
Under Voltage Warning	12 V	12 V	12 V	12 V	9-17 V
Low Voltage Disconnect	11.0V	11.0V	11.0V	11.0V	9-17 V
Over-Discharge Delay Time	5 s	5 s	5 s	5 s	1-30 s
Equalization Duration	----	2 hours	2 hours	----	0-10 Hrs.
Equalization Interva	----	30 Days	30 Days	----	0-250 Days
Boost Duration	2 hours	2 hours	2 hours	----	1-10 Hrs.

1. Default charging parameters in LI mode are programmed for 12.8V LFP battery. Before using Rover to charge other lithium battery, set the charging parameters according to the suggestions from battery manufacturer.
2. The above parameters are based on 12V system settings. Parameters are multiplied by 2 for 24V systems, multiplied by 3 for 36V systems, and multiplied by 4 for 48V systems.
3. For Equalization Interval Setting under USER mode, 0 Day refers to turning off the equalization function.

When selecting User, the battery type is to be self-customized, and in this case, the default system voltage parameters are consistent with those of the sealed lead-acid battery. When modifying battery charging and discharging parameters, the following rule must be followed:

- Over-voltage cut-off voltage > Charging limit voltage \geq Equalizing voltage \geq Boost voltage \geq Floating charging voltage > Boost recovery voltage;
- Over-voltage cut-off voltage > Over-voltage cut-off recovery voltage;
- Low-voltage cut-off recovery voltage > Low-voltage cut-off voltage \geq Discharging limit voltage;
- Under-voltage warning recovery voltage > Under-voltage warning voltage \geq Discharging limit voltage;
- Boost recovery voltage > Low-voltage cut-off recovery voltage

PV Power – Conversion Efficiency Curves

Illumination Intensity: 1000W/ m²

Temp 25 C

1. 12 Volt System Conversion Efficiency

2. 24 Volt System Conversion Efficiency

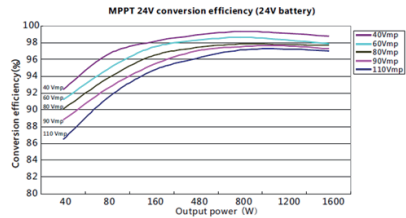
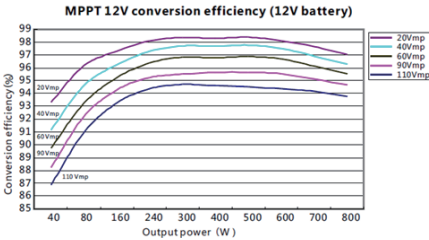

3. 48 Volt System Conversion Efficiency

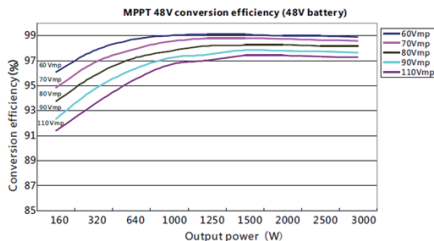

Dimensions

RVR60

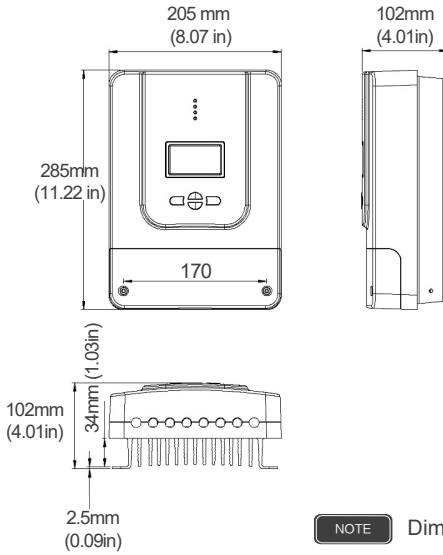

NOTE Dimensions in millimeters (mm)

RVR60 with mounting brackets

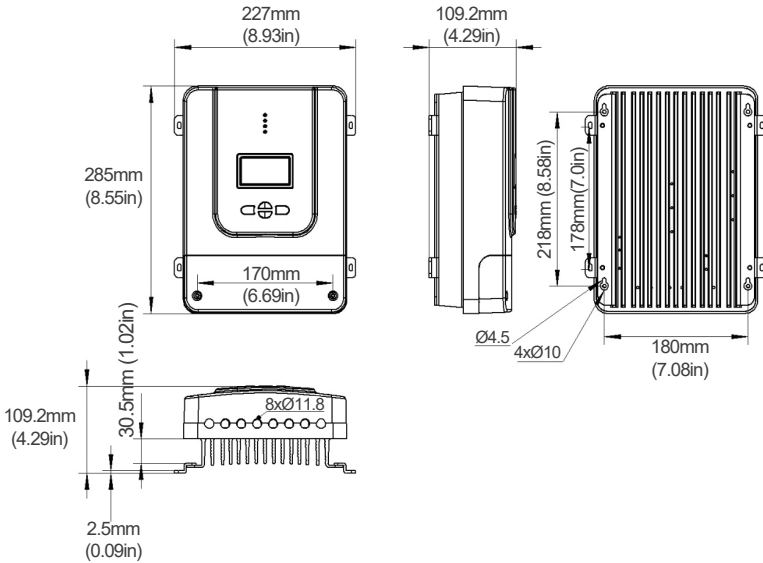

Renogy reserves the right to change the contents of this manual without notice.