

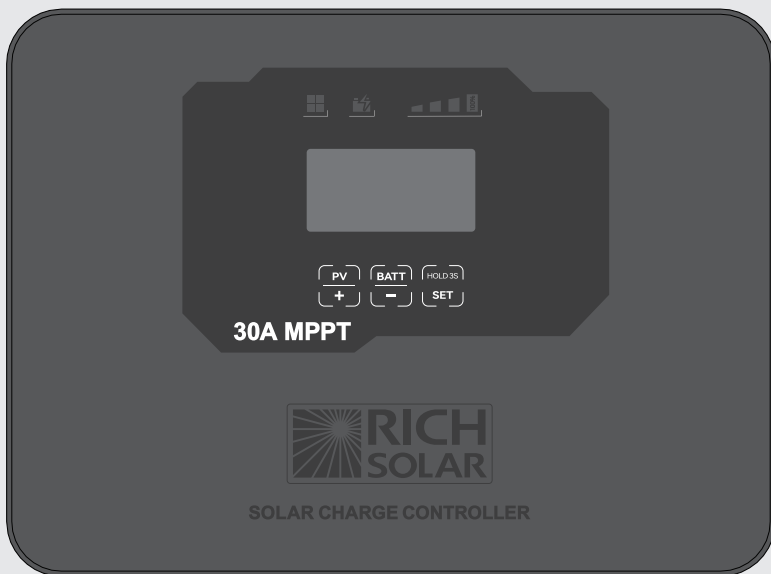

# User Manual

**30A MPPT**  
Solar Charge Controller



Input: DC 100V Maximum  
Output: DC 12V / 24V 30A

**MODEL: RS-MPPT30FM**

THIS MANUAL CONTAINS IMPORTANT SAFETY AND OPERATING INSTRUCTIONS FOR MPPT SOLAR CHARGE CONTROLLER. YOU READ THIS MANUAL AND FOLLOW THE INSTRUCTIONS EXACTLY.

- 02** WARNING – IMPORTANT PLEASE READ
- 02** MOUNTING AND INSTALLATION
- 05** WIRING CONNECTIONS
- 06** OPERATING – LCD DISPLAY
- 10** CHARGING STAGE
- 11** LED INDICATIONS
- 12** SAFETY PROTECTIONS
- 12** MAINTENANCE
- 13** SPECIFICATIONS
- 15** FEATURE AND ADVANTAGE

## **WARNING – IMPORTANT PLEASE READ**

**RISK OF EXPLOSIVE GASES WORKING IN VICINITY OF A LEAD-ACID BATTERY IS DANGEROUS. EXPLOSIVE GASES DEVELOP DURING NORMAL BATTERY OPERATION. IT IS IMPORTANT THAT EACH TIME BEFORE USING OR CONNECTING YOUR SOLAR CONTROLLER:**

- This charger is designed for indoor use only and should never be exposed to rain.
- Do not disassemble the controller. Take to a qualified person if the unit requires repairing.
- Lead acid, LCO, LiFePO<sub>4</sub>, LTO batteries can be dangerous. Ensure no sparks or flames are present when working near batteries.
- Eye protection should always be used. Never short circuit the battery.
- Given sufficient light solar panels always generate energy even when they are disconnected.
- Accidental ‘shorting’ of the terminals or wiring can result in sparks causing personal injury or a fire hazard. We recommend that you cover up the panel(s) with some sort of soft cloth so you can block all incoming light during the installation. This will ensure that no damage is caused to the Solar Panel or Battery if the wires are accidentally short-circuited.
- Always install a battery fuse on each circuit including the solar controller.
- Do not reverse connect the wires to the solar panel or battery.

## **MOUNTING AND INSTALLATION**

This solar controller is designed to be mounted against a wall, especially for caravan use, out of the way but easily visible, please note, mounted on a vertical surface to optimize cable placement and cooling of the unit, indoor use, protected from the weather.

# 1. The mounting dimensions

Refer to the Fig.1 to know the panel size and depth.

Refer to Fig. 2 to get a cavity for flush mounting, make sure there is sufficient depth behind the controller or in the cavity.

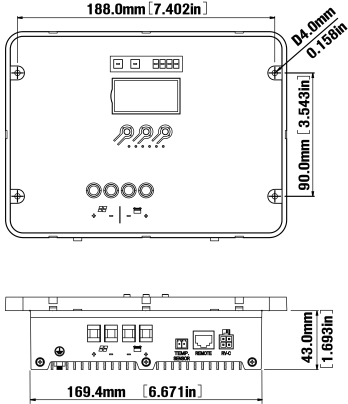

Fig.1

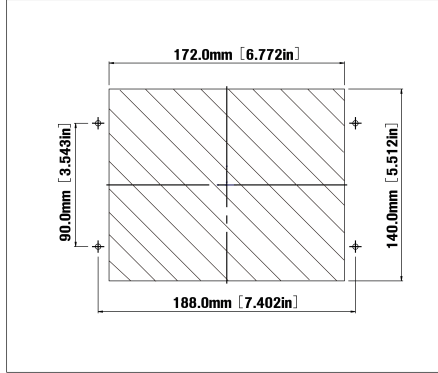

Fig.2

# 2. The installation preparation

Insert a slotted screwdriver into the slots at the below location of ① and ②, turn the screwdriver to separate the surface panel from the basement.

Take off the surface panel from the basement, you can see four screw holes on the top face.

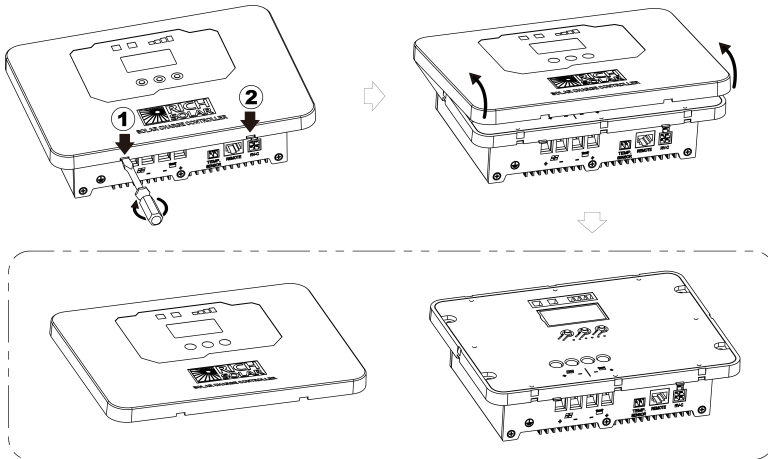

Fig.3



### 3. The installation procedures

Please see below steps from 1 ~ 6

Insert the input and output cables and firmly secure the cables to the solar controller via the screws, fit the controller to the cutout and wall, secure the controller to the wall, reinstall the surface panel back to the solar controller.

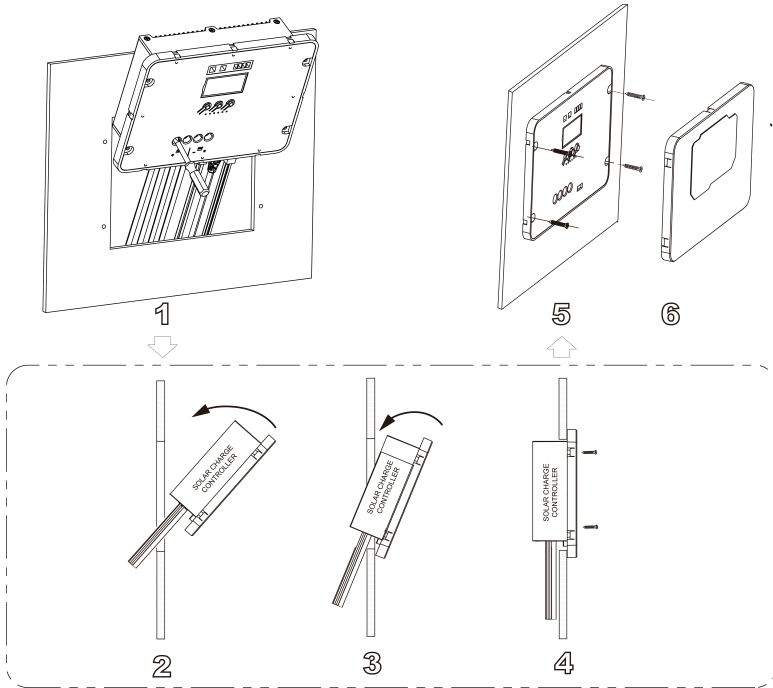

Fig.4

# WIRING CONNECTIONS

To protect the Battery and the Solar Panel, we strongly recommend that you place an inline fuse on the positive wire on both the “Solar” and “Battery” Circuits. 50A fuse for 40A controller; 40A fuse for 30A controller, (As close to the Battery /Panel as possible).

Refer to the below drawing, please cover the solar panel before connecting cables.

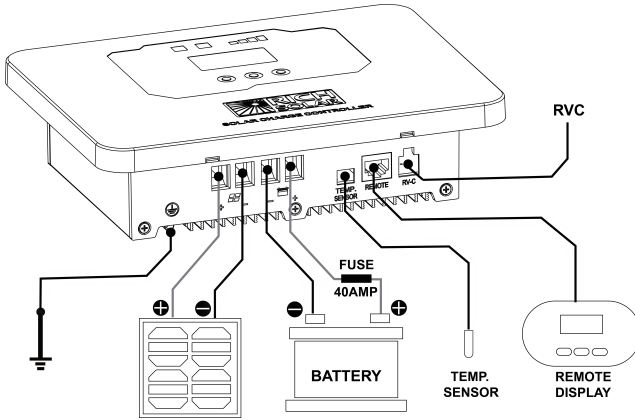

Fig.5

## Correct Wire Size

Please refer to the wire size chart below to determine the minimum size wire needed for each connection. This will also ensure you get the best performance out of your solar controller.

Rated Current	The cable total length One-way distance	Solar panel -> Controller -> Battery		
		< 3M	3-6M	6-9M
Rated Current	The cable total length One-way distance	Solar panel -> Controller -> Battery(meter)		
		< 3M	3-6M	6-9M
30/40Amp	The cable size (AWG)	10AWG	8AWG	6AWG

Rated Current	The cable total length One-way distance	Solar panel -> Controller -> Battery		
		< 10ft	10-20ft	20-30ft
Rated Current	The cable total length One-way distance	Solar panel -> Controller -> Battery(feet)		
		< 10ft	10-20ft	20-30ft
30/40Amp	The cable size (AWG)	10AWG	8AWG	6AWG

The solar controller is installed to close to the battery as near as possible.

Please do not reverse the connections with the solar panel and battery when installed the cables. Once the connections are completed, the Solar Controller will start working automatically.

## OPERATING – LCD DISPLAY

When the controller powers on, the unit will run self-qualify mode and automatically show below items on LCD before going into charging process.

8888	Self-test starts, digital meter segments test
r001	Software version test
12V 30A	System battery voltage and current test
r75 25 <sup>°</sup>	External battery temperature sensor test (if connected)
Ab5U 1420	Absorption voltage test
FLrU 1330	Float voltage test
End	Self-test completed

### System battery voltage setting

Press and hold the **SET UP button** for 3 seconds to go into the system battery voltage setting mode, press **PV / +** or **BATT / - button** to select your desired system battery voltage 12V, 24V or AUTO, press the **SET UP button** again to confirm the battery voltage setting.

The display in sequence,



The controller will automatically memorize your previous battery voltage setting, If AUTO mode selected, the controller will automatically detect 12V or 24V battery connected.

### System Battery type setting

Please check your battery manufacturer's specifications to select correct battery type. The unit provides 9+1 battery types for selections: LCO, LTO, LFP, Crystal (Lead crystal), Gel, AGM, WET (Conventional lead acid) and Calcium (Calcium contented) battery plus Custom setting.

Follow up the Battery voltage setting, Press the **SET UP button** to go into your battery type setting mode, the battery type you select will be flashed on the LCD meter, the default setting is AGM Battery; the controller will automatically memorize your battery type setting.

**Remarks:** LCO battery type setting is only recommended working with **3-SERIES** Lithium Cobalt Oxide LiCoO<sub>2</sub> battery.

LFP battery shown in LCD indicates Lithium Iron Phosphate battery, LiFePO4 battery.  
 LTO battery shown in LCD indicates Lithium titanate oxidized, Li4Ti5O12 battery.

**Caution:** Incorrect battery type setting may damage your battery.

Press **PV / +** or **BATT / -** button to navigate your desired battery type as below:

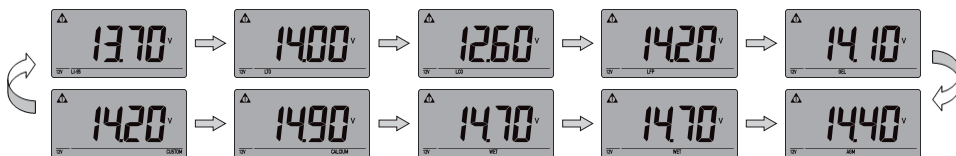

Press the **SET UP** button again, the selected battery type will be solid On and confirmed.

## Custom setting

This solar controller provides a CUSTOM mode to meet your special battery charging demand, the users can preset the Absorption voltage level and duration, Equalization voltage level, duration and periodical cycle, Float voltage level and Reset voltage level for your targeted battery charging parameters.

Alternatively display Absorption Voltage character **AbS.U** and voltage data when going into CUSTOM mode:

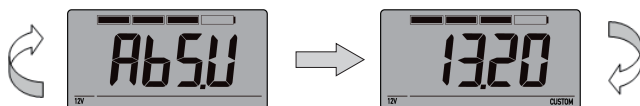

Absorption voltage setting range from 13.20V ~ 15.50V, press **PV / +** or **BATT / -** button for once +/- 0.05V variation, press the **SET UP** button again to confirm the absorption voltage level you preset, then move to next Absorption duration setting.

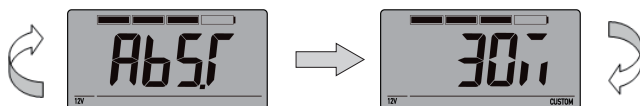

Alternatively display Absorption Time character **AbS.T** and duration data; Absorption duration setting lasted from 5 - 500 minutes, press **PV / +** or **BATT / -** button for once +/- 5 minutes variation, press the **SET UP** button again to confirm the absorption duration setting, then move to next Equalization voltage setting.

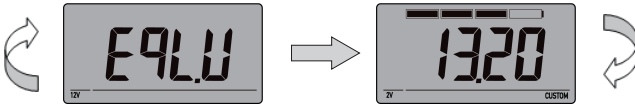

Alternatively display Equalization voltage character **EqL.U** and voltage data; Equalization voltage setting range from 13.20V ~ 16.2V, press **PV / +** or **BATT / - button** for once +/- 0.05V variation, press the **SET UP button** again to confirm the Equalization voltage and then move to next Equalization duration setting.

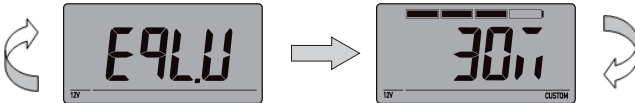

Alternatively display Equalization Time character **EqL.T** and duration data; Equalization duration setting lasted from 5 – 500 minutes, press **PV / +** or **BATT / - button** for once +/- 5 minutes variation, press the **SET UP button** again to confirm the Equalization duration setting and then move to next Equalization periodical cycle setting.

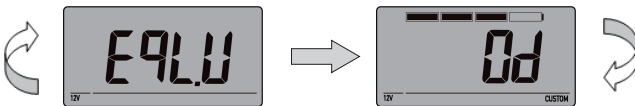

Alternatively display Equalization periodical cycle character **EqL.P** and cycle day; Equalization periodical cycle day setting from 0 – 100 days, press **PV / +** or **BATT / - button** for once +/- 1 day variation, 0 indicates no Equalization setting; press the **SET UP button** again to confirm the Equalization periodical cycle setting and move to next Float voltage setting.

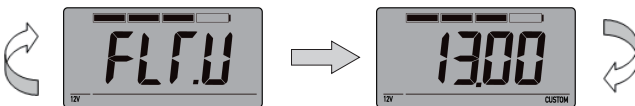

Alternatively display Float voltage character **FLT.U** and voltage data; Float voltage setting range from 13.00V ~ 14.00V, press **PV / +** or **BATT / - button** for once +/- 0.05V variation, press the **SET UP button** again to confirm the Float voltage and then move to next Reset/Restart setting.

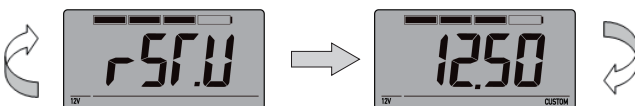

Alternatively display Reset/ Restart voltage character **rST.U** and voltage data; Reset voltage setting range from 12.50V ~ 13.50V, press **PV / +** or **BATT / - button** for once +/- 0.05V variation, press the **SET UP button** again to confirm the Reset / Restart voltage and all settings will be automatically stored.

## Solar input parameter display

Once the settings are completed, the solar controller will automatically go into charging process, the LCD displays the parameters of solar input as below:

Press **PV / + button** in sequence, the LCD will display in turn with solar input voltage, current, power and kWh.

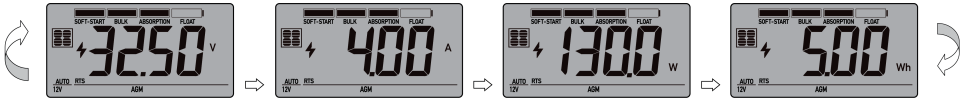

Press **BATT / - button** in sequence, the LCD will display in turn with battery voltage, charging current, charged capacity (Amp-hour) and battery temperature (if external temperature sensor connected).

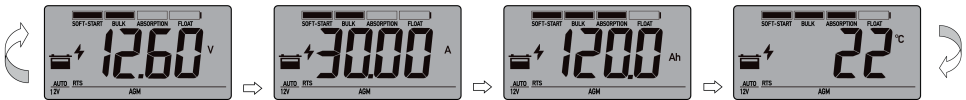

The users also can read the battery voltage as degree centigrade or Fahrenheit degree by pressing **SET UP button** for converting.

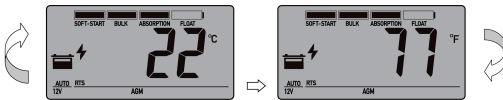

Alternatively display voltage and FUL when battery is fully charged.

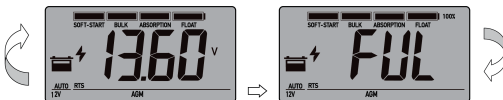

You also can visually monitor your battery charging condition for each battery; there is an LCD bar to show the percentage of charge, you can easily see the battery is charged to 25%, 50%, 75% or 100%, and also roughly match each charging stage of Soft-start, Bulk, Absorption and Float.

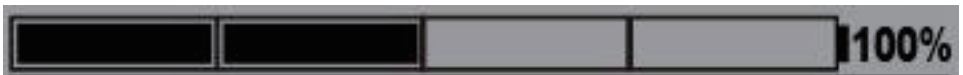

The LCD also can be treated as an independent voltage meter or thermometer at night.

# CHARGING STAGE

This solar controller provides multiple charging stages with smart charging algorithm.

For Lead acid battery (Crystal, Gel, AGM, WET and Calcium battery):

**Soft Charge – Bulk Charge – Absorption charge – Equalizing Charge\* – Float charge**

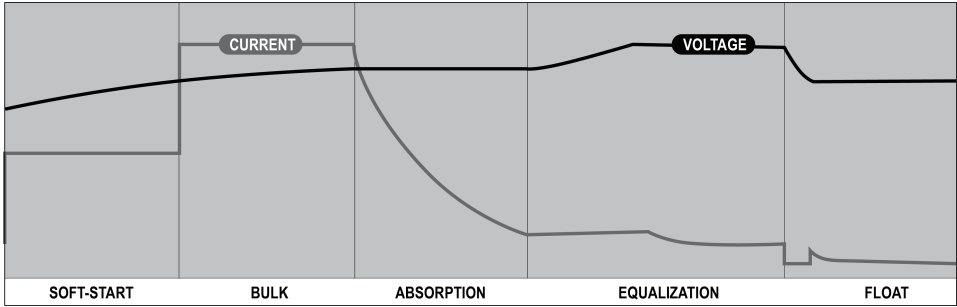

For Lithium battery (LCO, LFP, LTO battery)

**Soft Charge – Bulk Charge – Absorption charge – Stop and Restart charge\***

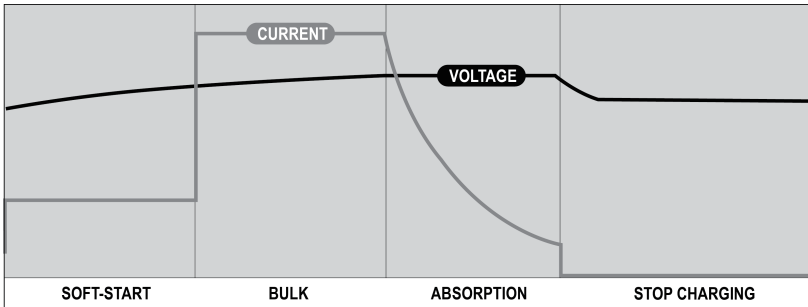

**Soft start –** When batteries suffer an over-discharge, the controller will softly ramp the battery voltage up to 10V.

**Bulk Charge –** Maximum current charging until batteries rise to Absorption level. For Lead crystal battery type, the charge controller will deliver two step level of Bulk charge, when the first level rises the battery voltage up to 14.4V, then switch into the second level of the 10% of the first bulk charge rate, until the Lead crystal battery voltage up to 14.7V.

**Absorption –** Constant voltage charging and battery is over 85% for lead acid battery; the Lithium battery (LCO, LFP and LTO battery) will close fully charged after absorption stage.

**Equalization \*** - Only for WET or Calcium battery type, when the battery is deeply drained below 10V or every 28 days cycle, it will automatically run this stage to bring the internal cells as an equal state and fully complement the loss of capacity. (Lead crystal, Gel, AGM battery or Lithium batteries do not run Equalization charge).

**Float Charge or Re-Start charge\* -**

Battery is fully charged and maintained at a safe level.  
 A fully charged Lead acid battery (Crystal, GEL, AGM, WET or Calcium battery) has a voltage of more than 13.6 Volts; if the lead acid battery voltage drops to 12.7V at float mode, it will return to Bulk charge, Lithium battery will stop charge after Absorption stage, it will restart to bulk charge if the voltage discharge less than 12.0V for LCO battery, 13.0V for LTO battery, 13.3V for LFP.



**Remarks:**

This controller provides an **override function** (force output delivery) for some heavily discharged Lead acid batteries (Low to 0V), or for some LiFePO4 batteries which are protected by BMS due to over-discharged.

Press **BATT / - button** for 3 seconds to wake up the Lithium battery (activate the BMS against protection) or override the Lead acid battery.





## LED INDICATIONS





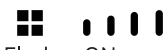





### Normal charge

LED indications						
LED Color	GREEN	BLUE	WHITE	WHITE	WHITE	WHITE
Soft-Start	ON	FLASH	FLASH	OFF	OFF	OFF
Bulk charge	ON	ON	ON	FLASH	OFF	OFF
Absorption / Equalization	ON	ON	ON	ON	ON	FLASH
Float charge	ON	OFF	ON	ON	ON	ON



## Abnormal charge

Solar panel abnormal mode	LCD display	LED indication	LCD backlight
Solar panel weak <15V	/	 Flash ON	ON
Solar panel reverse connection		 Flash Flash	Flash
Solar panel over voltage (> 95V)		 Flash Flash	Flash

Battery abnormal mode	LCD display	LED indication	LCD backlight
Solar panel is connected, battery disconnected		 Flash	Flash
Battery reverse connection		 Flash	Flash
Battery over voltage than > 17V		 Flash Flash Flash Flash	Flash
Battery temperature over 65°C		 Flash Flash Flash Flash	Flash
The controller over temperature protection		 ON	Flash

## SAFETY PROTECTIONS

- Reverse polarity solar and battery connection.
- Against reverse current from battery to solar panel at night.
- Over temperature protection with charging current de-rate.
- Transient overvoltage protection, a varistor or transient voltage suppressor (TVS) at the solar input and battery output against surge voltage.

## MAINTENANCE

Occasionally, clean the case using a damp cloth and mild cleaning agent. Check with terminals without loose, rusty; If connecting cable is damaged, replace the cable by qualified person.

# SPECIFICATIONS

## ELECTRICAL PARAMETERS

Maximum PV open circuit voltage at -20°C	100	Max.	VDC
Normal input PV voltage at 25°C	92	Max.	VDC
Max. PV input current	30	Max.	AMP
Max. PV short circuit current	35	Max.	AMP
Rated charging current	30	Max.	AMP
Conversion efficiency	98	Max.	%
Tracking efficiency	99.5	Min	%
Nominal PV power	500@12V/1000@24V		Watt
Self-consumption from battery when PV is disconnected	10	+/-0.5	mA
Output open circuit voltage when battery is disconnected	0.5	Max.	VDC
MPP voltage range	15-72	+/-0.5	VDC

## CHARGING CHARACTERISTICS

Minimum battery start charging voltage	5	Min	VDC
Soft start charging voltage	5-10	+/-0.2	VDC
Soft start charging current	15		AMP
Bulk charge	30	Max.	AMP
Absorption charging voltage at 25°C			
--LCO battery	12.6	+/-0.2	VDC
--LTO battery	14.0	+/-0.2	VDC
--LFP battery	14.2	+/-0.2	VDC
--Gel type battery	14.1	+/-0.2	VDC
--AGM type battery (default setting)	14.4	+/-0.2	VDC
--WET type battery	14.7	+/-0.2	VDC
--Lead Crystal battery	14.7	+/-0.2	VDC
--Calcium battery	14.9	+/-0.2	VDC
--Custom setting range	13.2-15.5	+/-0.2	VDC
Absorption transits to Equalizing or Float /Stop condition			
--Charging current drops to	1.5	+0.1	AMP
-- or Absorption charging timer timed out for Lead acid battery	4		Hour
-- or Absorption charging timer timed out for Lithium battery	0.5		Hour
Equalization charging activation			

-- Only for WET or Calcium battery			
-- Battery voltage discharged less than	10	+/-0.2	VDC
-- Automatic equalizing charging periodical	28		Day
Equalization charging voltage at 25°C	15.5	+/-0.2	VDC
Equalization charging timer timed out	2		Hour
Equalization charging voltage for CUSTOM setting	13.2-16.2	+/-0.2	VDC
Float voltage (for Crystal, GEL, WET, AGM and Calcium battery) at 25°C	13.6	+/-0.2	VDC
Restart voltage			
-- for Crystal, GEL, WET, AGM and Calcium battery)	12.7	+/-0.2	VDC
-- for LCO battery	12.0	+/-0.2	VDC
-- LTO battery	13.0	+/-0.2	VDC
-- LFP	13.3	+/-0.2	VDC
-- for CUSTOM setting range	12.5-13.5	+/-0.2	VDC
Voltage control accuracy	+/- 1%		
Battery temperature compensation coefficient	-24		mV/°C
Temperature compensation range	-20~+50		°C

#### **ELECTRICAL PARTS**

Input output terminal	Rated 50A connector
-----------------------	---------------------

#### **PHYSICAL PARAMETERS**

Controller material	Plastic, PC
Mounting	Surface mounting
IP grade	IP43,
Net weight	Approx. 0.8KG

#### **ENVIRONMENTAL CHARACTERISTICS**

Operating temperature	-25 ~ 50°C / -13 ~ 122 °F
Storage temperature	-40 ~ 85°C / -40 ~ 185 °F
Operating Humidity range	0-85% RH

**Remarks:** Battery Voltage settings for 12V mode, x2 for 24V mode.

## FEATURE AND ADVANTAGE

- PV open circuit voltage up to 100V.
- The latest Maximum Power Point Tracking (MPPT) algorithm.
- Unique multiple peaks detected technology for maximum power point tracking.
- MPPT tracking efficiency above 99.5%.
- Wider MPP operating voltage range.
- Common negative grounding connection.
- Suit for most rechargeable batteries, up to 9 battery types preset plus custom setting.
- Extensive internal electronics in-circuit protection.
- Reliable operating safety protection: overcharging or undercharging protection, short circuit protection, reverse polarity protection, thermal protection.
- Automatically detect 12V or 24V DC system voltages.
- Unique and concise LED bar to indicate the solar statues and battery charging condition.
- Large and informative display interface to show Solar parameter, battery charging parameter, battery type, battery temperature, custom presetting and faulty codes, etc.
- Provides plug-in remote digital display meter (Optional).
- Provides external battery temperature sensor (Optional).
- Splash proof IP43.
- Rubber mask for connecting terminals protection.
- Conformal coating for internal boards.
- Designed according to UL1741, EN/IEC 62109-1; EMI standard: EN61000-6-1/EN61000-6-3 and FCC standard: 47 CFR Part 15, Subpart B.