

# PCL SERIES

2000W / 3000W

Pure Sine Wave Inverter & Charger

# RENOGY

Version 3.0



# CONTENTS

General Information .....	04
Product Overview .....	05
Identification of Parts .....	05
Dimensions .....	07
Included Components .....	07
Installation .....	09
Location Recommendations .....	09
Sizing A Battery Bank .....	10
Grounding .....	10
DC WIRING .....	11
AC WIRING .....	12
Automatic Neutral-to-Ground Bond Switching .....	13
Automatic Transfer Relay .....	15
Auto Generator Start .....	15
Operation .....	16
Fan Operation .....	16
Main Menu .....	16
05 Setup Battery Type .....	20
05 Custom Battery Type /User Mode .....	21
Display Panel .....	22
LCD Display Icons and Behaviors .....	23
Programmable Features .....	26
01 Utility Priority and Battery Priority .....	26
03 AC Input Voltage Range .....	27
04 Power Saving Mode .....	28
07 Auto Restart Temperature Fault .....	28
09 Output Frequency .....	28
11 Maximum Utility Charging .....	29
12 Low Battery Voltage Setpoint .....	29
13 Over-Voltage Battery Recovery .....	29
18 Alarm Control / Behavior .....	29
19 Screen Mode .....	30
20 LCD Screen Mode .....	30
22 Normal Mode Sound .....	30
25 Record Fault Code .....	31
26 Boost Charging .....	31
27 Float Charging .....	31
29 Low DC Cut-off Voltage .....	31
93 Input Frequency Range .....	32
94 Selection of Battery Type Custom .....	32
95 Battery High Voltage for Dry Contacts .....	32
96 Low Voltage Trip for Dry Contacts .....	33
97 Dry Contact Control .....	33
98 Low Battery Voltage Alarm .....	34
99 AC output Voltage .....	34
Battery Charging Stages .....	35
Fault / Warning Codes .....	36
Technical Specifications .....	37



## Important Safety Instructions



Please save these instructions.

This manual contains important safety, installation, and operating instructions for the inverter. The following symbols are used throughout the manual:

**WARNING**

Indicates a potentially dangerous condition. Use extreme caution when performing this task.

**CAUTION**

Indicates a critical procedure for safe and proper operation of the inverter.

**NOTE**

Indicates a procedure or function that is important to the safe and proper operation of the inverter.

### ■ General Safety Information

- Installation and wiring must comply with the Local and National Electric Codes (NEC) and must be done by a certified technician.
- Read all of the instructions and cautions in the manual before beginning the installation.
- There are no serviceable parts for this inverter. Do NOT disassemble or attempt to repair the inverter.
- Make sure all connections going into and from the inverter are tight. There may be sparks when making connections, therefore, make sure there are not flammable materials or gases near installation.

### ■ Inverter Safety

- The inverters are suitable for 12V Battery Banks ONLY.
- ALWAYS make sure inverter is in OFF position and disconnect all AC and DC connecting when working on any circuit associated with the inverter.
- NEVER connect the AC output of the unit directly to an Electrical Breaker Panel/ Load Centre which is also fed from the utility power / generator.
- When connecting battery terminals, ensure the polarity of the battery connections is correct. Incorrect polarity may cause permanent damage to the unit.
- Be careful when touching bare terminals of capacitors as they may retain high lethal voltages even after power is removed.

---

## ■ Battery Safety

- Do NOT let the positive (+) and negative (-) terminals of the battery touch each other.
- Use sealed Lead-Acid, Flooded, Gel, AGM, Lithium or Calcium batteries which must be deep cycle.
- Explosive battery gases may be present while charging. Be certain there is enough ventilation to release the gases.
- Be careful when working with large lead acid batteries. Wear eye protection and have fresh water available in case there is contact with the battery acid.
- Over-charging and excessive gas precipitation may damage the battery plates and activate material shedding on them. Too high of an equalizing charge or too long of one may cause damage. Please carefully review the specific requirements of the battery used in the system.

## ■ Installation Safety

- The unit should be installed in a well-ventilated, cool, and dry environment. Make sure the fans of the unit and the ventilation holes are not blocked.
- Do not expose the unit to rain, moisture, snow, or liquids of any type.

## General Information

The Renogy PCL series inverter-chargers combine an inverter and battery charger with an automatic transfer switch into one complete system. Featuring a 3-stage battery charging mode when connected to utility AC power, the PCL series inverter-charger can meet powerful demand needs as well as charge your battery bank. As a power supply, it is capable of producing cleaner, smoother, and more reliable electricity for a user's electronic needs. Take full advantage of the multiple features.

### ■ Key Features

- Robust and sleek design
- LCD and LED display used to view inverter status and programming features
- Offers high quality waveform with little harmonic distortion
- 4-Stage battery charger with configurable charging current
- 8 Pre-Set battery voltages including Lithium; User-defined option available
- Automatic generator start option
- Peak efficiency >90%
- Multiple electronic protections

# Product Overview

## Identification of Parts

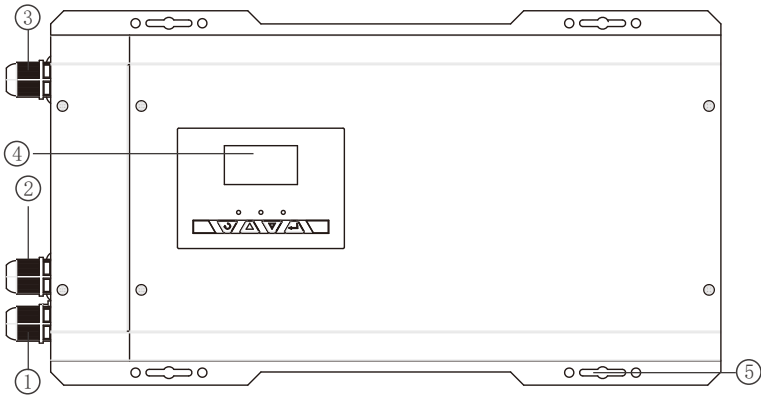

Top view

1. AC Input Cable Entry
2. AC Output Cable Entry
3. Wired Remote Control Cable Entry
4. LCD Panel and Buttons
5. Mounting Holes

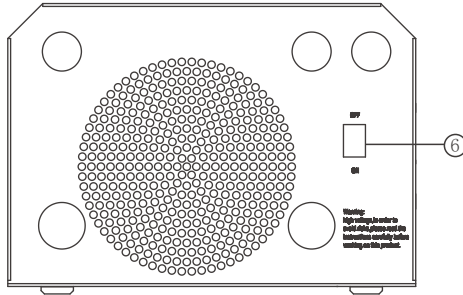

Left View (Covered)

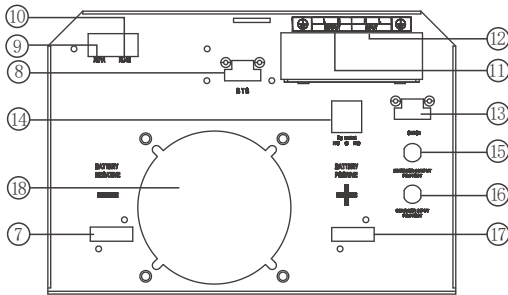

Left View (Uncovered)

6. Main ON/OFF Switch: This is a simple ON/OFF switch to be able to control the inverter with the plate in place. The wiring is connected to the Terminal Block on the inside of the plate seen in 13.
7. DC Negative Battery Terminal
8. Battery Temperature Sensor Port: Non-polarity sensitive port that connects the included temperature sensor to the PCL unit.
9. RJ11 Port: Port for connecting Wired Remote Control
10. RJ45 Port for Future Development
11. AC Output Terminal Block
12. AC Input Terminal Block
13. Main Power Switch Terminal Block
14. Dry Contact Relay Port: NC, C, NO ports for connecting generators and making use of the Auto-Gen Start feature.
15. Inverter Output Protection Circuit Breaker
16. Inverter Input Protection Circuit Breaker
17. DC Positive Battery Terminal
18. Fans that dissipate heat

## ■ Dimensions

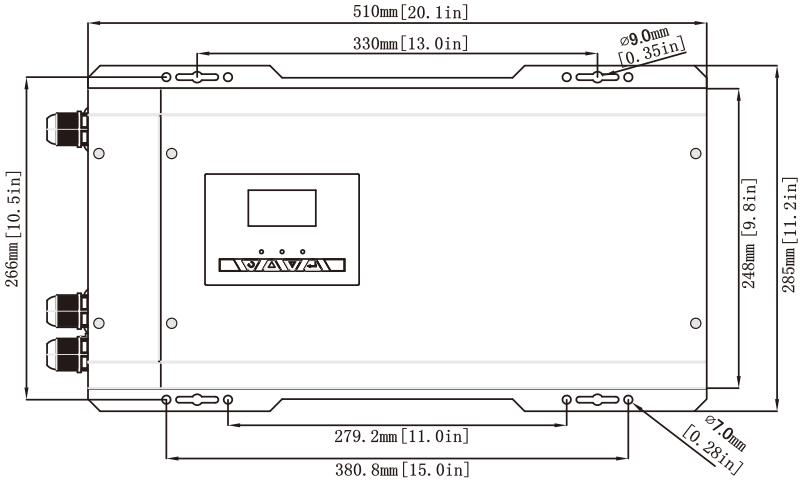

Note: Dimensions are in millimeter[inches]

## ■ Included Components

### Battery Temperature Sensor (BTS)

Renogy inverter chargers come equipped with a 9.9 ft / 3 meter battery temperature sensor that will help prolong the battery life. The battery sensor allows the inverter charger to continuously adjust the charging voltage based on the battery temperature. The inverter charger will compensate charging with a factor of 5mV/C° per degree after 77F°/25C°, within -40C°/F° ~ 176F°/80C°. The sensor should be installed on all battery banks except for lithium. Simply connect the wire into the terminal block (it is not polarity sensitive), if it is not connected already. The terminal block may need to be tightened onto the respective BTS port. Then place the sensor near the battery bank for automatic temperature compensation.

NOTE

Connect the temperature sensor for all batteries except Lithium for best charging accuracy





## Wired Remote Control

The wire remoted control for the inverter chargers gives users the opportunity to power on/off the inverter from a distance. Giving you approximately 16.4ft of distance, simply connect the cable to the RJ11 port on the PCL unit. Make sure both the PCL inverter model and the wired remote are both in the off position. The you will be able to turn on the inverter charger via remote power switch.

**NOTE**

Make sure the PCL is in the off position in order to use the wired remote control correctly.



# Installation

**WARNING** Make sure inverter is in the off position before connecting anything.

**CAUTION** Do not over-torque or over tighten the terminals. This could potentially damage the unit.

**CAUTION** Refer to the technical specifications for max wire sizes on the controller and for the maximum amperage going through wires.

## ■ Location Recommendations

**WARNING** Never install the inverter in a sealed enclosure with flooded batteries. Gas can accumulate and there is a risk of explosion.

### Ensure installation follows the following guidelines:

1. **Cool, dry, well-ventilated area** — Heat is the worst enemy for electronic equipment. Inverters must be in an area where the fans are not blocked or where they are not hit directly by the sun. They should be in an area free of any kind of moisture and allow for clearance of at least 10" around the unit to provide for adequate ventilation.
2. **Protection against fire hazard** — the unit should be away from any flammable material, liquids, or any other combustible material. The unit can spark and the consequences could be severe.
3. **Close proximity to battery bank**—prevent excessive voltage drop by keeping the unit close to the battery bank and having a properly sized wire going from the battery bank to the inverter.
4. **WARNING Do not install the inverter in the same compartment as the battery bank because it could serve as a potential fire hazard.**
5. **Limiting electromagnetic interference (EMI)** — ensure the inverter is firmly grounded to a building, vehicle, or earth grounded. Keep the inverter away from EMI receptors such as TVs, radios, and other audio/visual electronics to prevent damage/interference to the equipment.
6. **Secure inverter**—the inverter could be stand alone or mounted using the outlying terminals on the inverter.

**WARNING** The inverter should never be mounted vertically on a vertical surface since it would present a hazard for the fan opening which is crucial for cooling the inverter.

---

## ■ Sizing a Battery Bank

- **Determine the amount of Watts (Amps \* Volts) for the load, and how long the load needs to operate**—each electrical appliance has technical specifications indicating the watts, or the volts and amps required for operation.
- **Estimate load run-time**—Battery size depends on load watts and run-time. Most loads are not constant, so estimation is very important.
- **Utilize the formula Watts = Volts \* Amps**
- **Determine Amps used for how many hours – Amp-hour (Ah)**

**For this Renogy inverter, the battery bank will be 12 volts direct current (12 VDC)**

Example	
A Microwave oven = 700 Watts 12V battery bank	700 Watts to run microwave oven using the batteries as if it was a 12VDC microwave requires 58 Amps $700 \text{ Watts} / 12 \text{ Volts} = 58 \text{ Amps}$
Load Operation = 3 hours	Now that amps have been determined, the amp-hours need to be determined. The microwave will be used for approximately 3 hours a day. $58 \text{ Amps} * 3 \text{ hours} = \underline{174 \text{ Ah}}$
At least a 174 Ah battery must be selected in order to use the 700-Watt microwave at 3 hours a day. However, determining a battery size is also dependent on the battery that is able to handle repeated discharge/charge cycles.	

**NOTE**

This is just an example. Actual quantities vary by battery capacity and rates of discharge.

**NOTE**

To power the microwave in the example, the user may need to use an inverter that is 1400W or more depending on surge and power factor..

## ■ Grounding

Grounding for the PCL Inverter-chargers could be to a metal frame of an RV. The connections to ground must be tight and against bare metal. Whether using the inverter in a mobile application, such as an RV or in a building, grounding is highly recommended. The recommended wire size for grounding is 8 AWG copper wire. For more information regarding grounding, users and/or installers must consult with the Local and National Electric Codes (NEC) for more specific grounding regulations and suggestions as they can change per scenario.

## DC WIRING

**WARNING**

The Renogy Pure Sine Wave Inverters are suitable for 12V battery bank systems ONLY. Not following the minimum DC requirement will cause irreversible damage to the unit.

**CAUTION**

Be careful of the positive and negative poles. Reversing the poles might cause permanent damage to the inverter. It will surely blow the internal fuse.

**NOTE**

Damage to the Renogy inverters due to reverse polarity is NOT covered by warranty.

**NOTE**

The input terminals of the inverters have large capacitors connected to them. Once a positive and negative wire are connected to the terminals, it will complete the circuit, and commence drawing a heavy current momentarily. As a result, there may be a sparking occurring even if the inverter is in the off position. To minimize sparking, it is recommended that the user have the appropriate size wire feeding into the inverters and/or install an external fuse leading into the inverter.

**WARNING**

Ensure all sources of DC power (i.e., batteries, solar, etc.) and AC power (utility power or AC generator) are de-energized (i.e., breakers opened, fuses removed) before proceeding—to prevent accidental shock.

To Access the main panel, unscrew the terminals on the outside of the side panel.

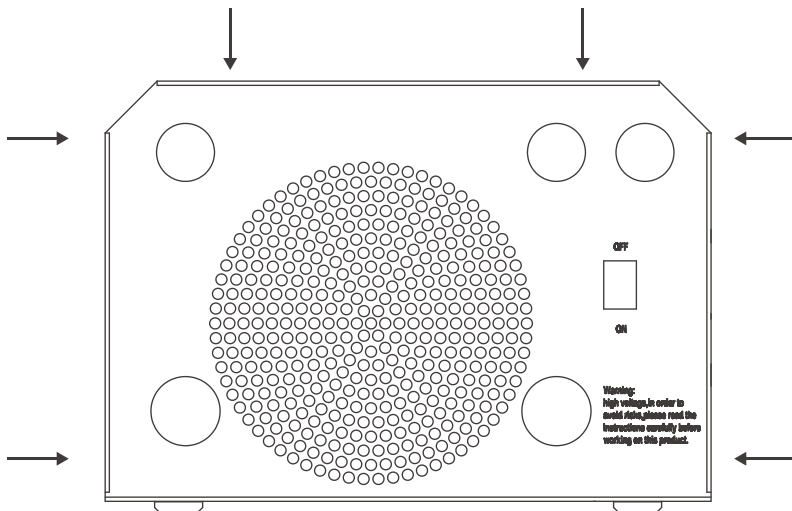

1. Flip inverter power to the "OFF" position
2. Unscrew the screw terminals along the edge of the side plate
3. Gently remove DC Side plate to expose DC Terminals
4. Connect the positive and negative DC Cables to their respective terminals and run them through the side panel

**NOTE**

The Terminals must clean to reduce the resistance in the cable connection. A buildup of dirt or oxidation may eventually lead to the cable terminal overheating during periods of high current draw

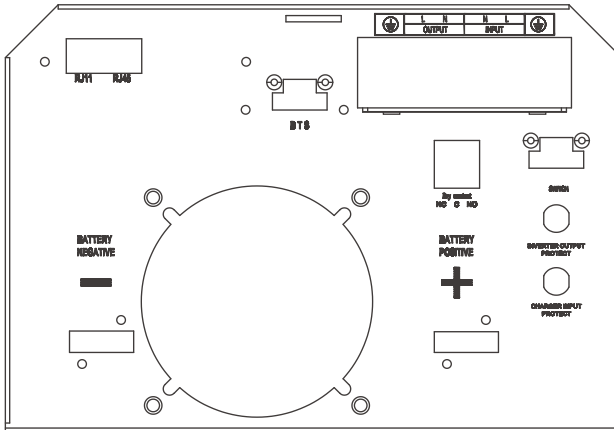

---

When installing DC cables, the following are recommendations:

1. Battery positive and negative cables should be as close to the battery as possible to minimize voltage loss and other possible effects.
2. Tie, tape, or twist cables together to reduce self-inductance.
3. Install all overcurrent devices on the positive cable.

Model	Recommended Fusing	Recommended Wire Sizing
2000W	200A	2/0
3000W	300A	4/0

## ■ AC WIRING

**CAUTION** Avoid switching on the inverter with the load (electronic devices) already switched on. This may trigger an overload since some electronic devices have an initial high power surge to start.

**CAUTION** When switching off the inverter, turn off the electronic devices first. Although the inverter is off, the capacitors will still have a charge, so the DC and AC terminals must be disconnected if altering the circuitry.

**WARNING** Ensure all sources of DC power (i.e., batteries, solar, etc) and AC power (utility power or AC generator) are de-energized (i.e., breakers opened, fuses removed) before proceeding—to prevent accidental shock

---

1.Remove the AC Terminal block

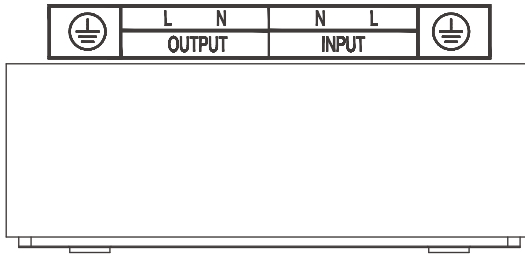

2.Make note of the AC output terminals from left to right (Ground, Live, Neutral) and the AC Input terminals from left to right (Neutral, Live, Ground).

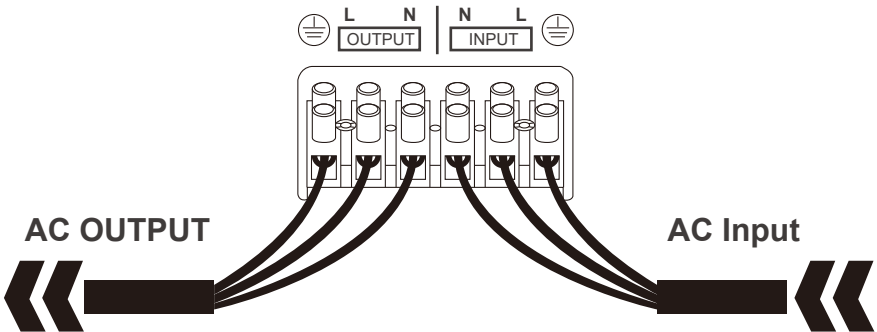

**WARNING**

The AC input must never be connected to the AC output as irreversible overload or damage may result

**WARNING**

AC Output should NEVER be connected to public power or a generator

---

## ■ Auto Generator Start

NOTE

To use this to function, an auto start controller must be installed on the generator.

NOTE

there are three contacts; left to right: Normally Closed (NC) Common (COM), Normally Open (NO).

WARNING

Do not store units with auto gen start feature enabled. Generators exhaust dangerous fumes when running.

The PCL inverter charger series have functions to automatically start and stop a generator for supplementing charge. The Auto Generator feature starts the Generator with the use of Normally Closed (NC) contacts of the relay that “opens” when the battery voltage drops to the programmed value of Program 96, Low Battery Voltage Set-point. The Normally Open (NO) relay “closes”, and the auto generator start commences the generator to start charging the battery bank. When the battery is recharged and its voltage rises to the programmed value of Program 95, High Battery Voltage Set-point The NC (closes) contacts and NO (open) contacts of relay reset and the Generator will stop / shut down the Generator automatically. The PCL unit will then transfer back to “Inverting Mode”.

NOTE

While the generator is connected, the unit now operates in “Charging Mode” with the AC power from the Generator charging the batteries as well as providing power to the AC loads.



# Operation

Upon successful connection of a 12V deep cycle battery bank, flip the inverter power to the ON position.





NOTE

Upon successful connection of a 12V deep cycle battery bank, flip the inverter power to the ON position.

NOTE

The unit may also be powered on by the wired remote control.

## Function Keys

	Exit setting mode, go back to main menu
	Cycle through the menu
	Cycle through the menu
	1. Hold down to enter Parameter setting menu. 2. Tap to change/confirm setting in parameter setting menu

## FAN Operation

NOTE

By default, when first powering the unit the fans and alarm will run for approximately 1 minute as part of the start-up routine. Other fan ON/OFF operation parameters are listed below:

Condition	Turn on Condition	Turn off Condition
Inverter Charger Uptime	Uptime $\leq$ 1 minute	Uptime $>$ 1 minute
Inverter Mode Load Percentage	Load $\geq$ 35%	Load $<$ 35%
Charging Current	Current $\geq$ 10A	Current $<$ 6A
Inverter Heat Sink Temperature	Temperature $\geq$ 50 °C	Temperature $<$ 45 °C

## Main Menu

Use the up and down arrows to cycle through the menu. The following is what is displayed:

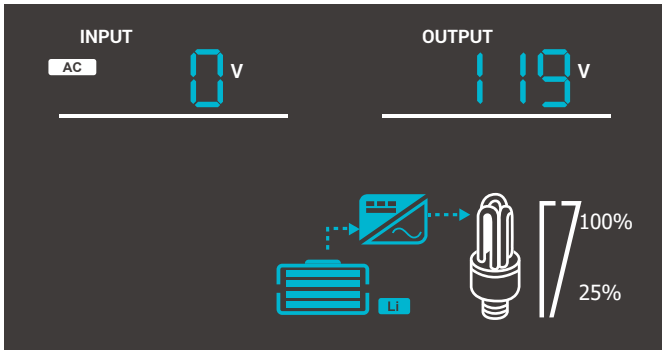

Input Volts AC / Output Volts AC

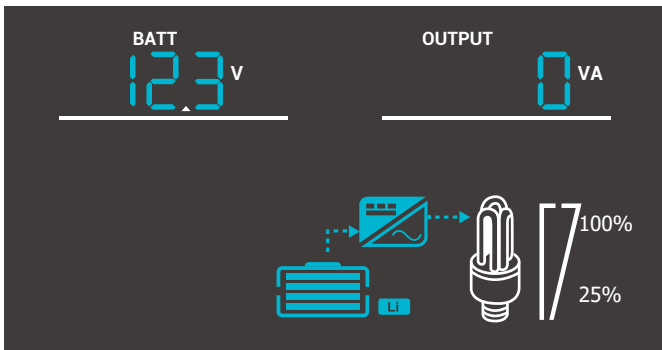

Battery Volts DC / Load Volts AC

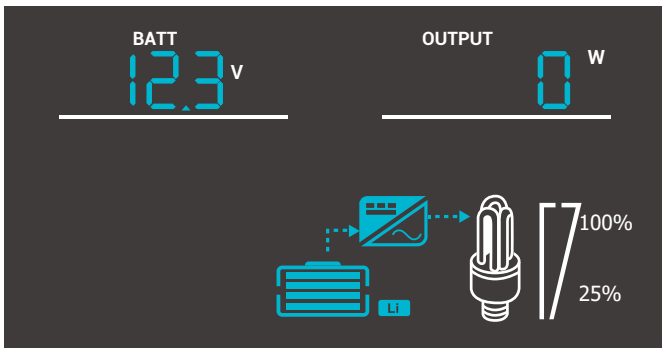

Battery Volts DC / Output Watts

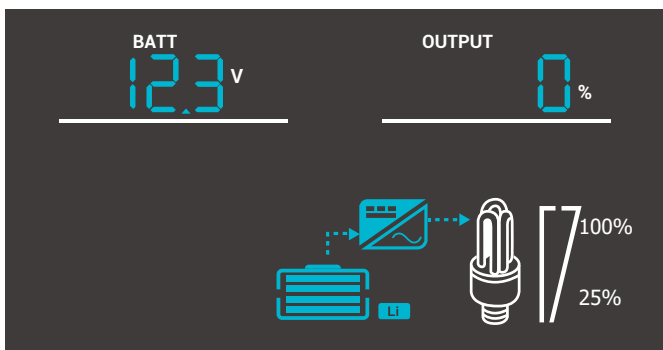

Battery Volts DC / Output Load %

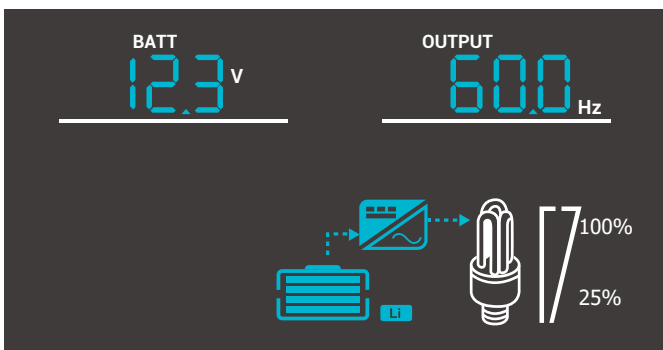

Battery Volts DC / Output Frequency

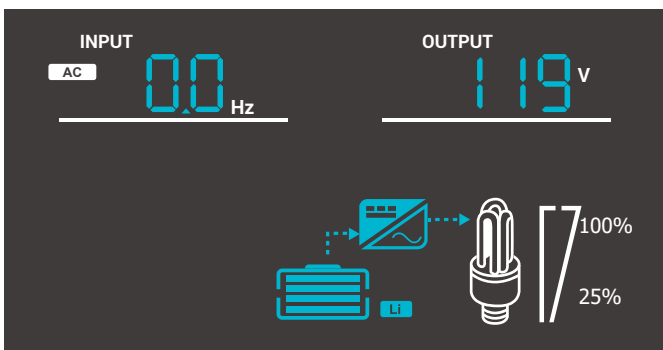

Input Frequency / Output Volts AC

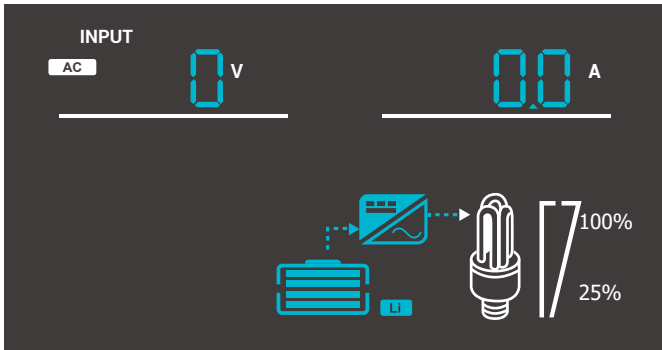

Input Volts AC / Input Amps

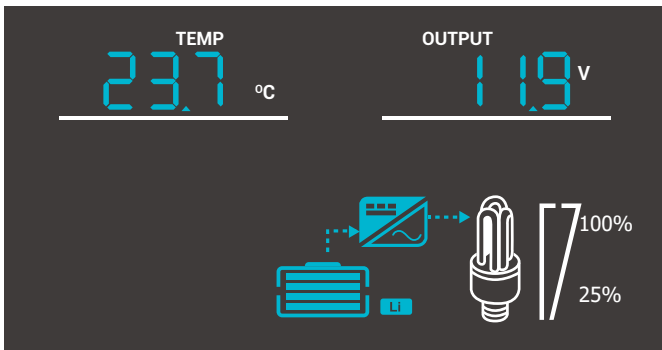

Inverter Temperature Celsius / Output Volts AC

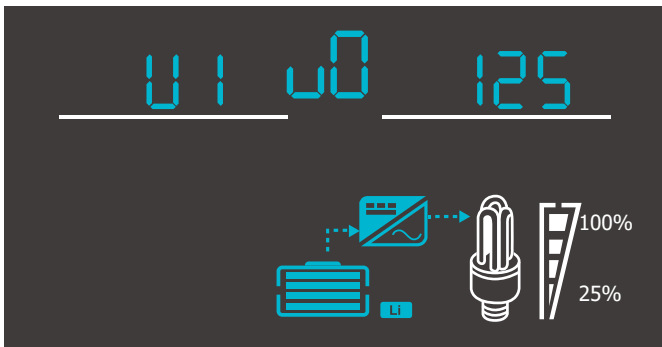

Inverter Version Number

## 05 Setup Battery Type

The PCL inverter charger series is fully programmable. The minimum programming needed to get started would be to set the battery type. Press and hold the parameter setting key to enter parameter setting mode. Use the arrow keys to go to Program 05. Use the following table to set the appropriate battery type based on the boost voltage and float voltage that has been preset.

**NOTE** The PCL series is only compatible with 12V battery banks.

Program Number	Description	Parameter Setting	Boost Voltage	Float Voltage
05	Battery type  For Charging to be accurate, Temperature Sensor must be connected.	Type of battery		
		Gel 1 05 <u>b-1</u>	14.0	13.7
		A.G.M.1 05 <u>b-2</u>	14.1	13.4
		A.G.M.2 05 <u>b-3</u>	14.6	13.7
		Sealed Lead Acid 05 <u>b-4</u>	14.4	13.6
		Gel 2 05 <u>b-5</u>	14.4	13.8
		Open Lead Acid / Flooded 05 <u>b-6</u>	14.8	13.8
		Calcium 05 <u>b-7</u>	15.1	13.6
		De-sulphation 05 <u>b-8</u>	15.5 for 4 hrs	
Li 05 <u>b-L</u>	When battery voltage reaches 14.7V charging will stop. When battery voltage drops below 12.5V charging will resume.			

**NOTE** Lithium charging is preset to 14.7V charging. When charging the battery and it reaches the 14.7V setpoint it will stop charging the battery. Upon normal use, when the voltage of the battery drops down to 12.4 and below, charging will resume.

## 05 Custom Battery Type /User Mode

If the preset battery options are not compatible with your system, you will need to custom the charging by following the next steps.

**1. Set the battery type to b-0. By default this unit is preset to boost at 14.3V and Float at 13.7V.**

Program Number	Description	Parameter Setting	
05	Battery type For Charging to be accurate, Temperature Sensor must be connected.	User-defined (default fast V 14.3, Floating V 13.7) 05 b-0	If User-Defined is selected ,user can set the battery type in program94

**2.Go to Program 94 to determine whether the custom battery is a Lithium or non-lithium battery, Refer to the chart below:**

Program Number	Description	Parameter Setting	
94	Selection of battery type	Lithium battery 94 ALb	If selected, battery charge voltage and battery low open charging can be set up in program 26,27
		Other battery 94 0Lp	If selected ,battery charge voltage can be set up in program 26,27

**3.If choosing a custom lithium battery, make sure the previous Program 94 is at ALb. Otherwise if programming a non-lithium battery skip to Step 4.**

a.After setting Program 94, go to Program 26 to select the maximum charging voltage for your custom lithium battery. Please Note when the voltage set point is reached, the custom lithium battery will stop charging

Program Number	Description	Parameter Setting	
26	Maximum charging voltage for Lithium battery. When the voltage reaches the set voltage, charging will stop.	60C 26 130 <sup>BATT</sup> V	If User-defined is selected in program 94,this program can be set the maximum charging voltage.Setting range is from 13.0V-15.5V

b. Once finished, go to Program 27 to set the battery low voltage recovery charge. This will be the voltage that the battery discharges to before the inverter-charger charges the battery to the predetermined maximum charging voltage

Program Number	Description	Parameter Setting
27	Battery low voltage open charging (for lithium battery)  LC	If User-defined is selected in program 94, this program can be set up. Setting range is from 12.0V to 14.0V for 12V  LC 27 120 <sup>BATT</sup> V

#### 4. If choosing a custom non-lithium battery (i.e., Deep cycle), make sure Program 94 is set to 0tP

a. After setting Program 94, go to Program 26 to select the boost charging voltage for your custom non-lithium battery.

Program Number	Description	Parameter Setting
26	Bulk charging voltage (C.V voltage)  EV	If User-defined is selected in program 94, this program can be set up. Setting range is from 13.0V to 15.0V  EV 26 130 <sup>BATT</sup> V

b. Once finished, go to Program 27 to set the battery float charge.

Program Number	Description	Parameter Setting
27	Floating charging voltage  FLV	If User-defined is selected in program 94, this program can be set up. Setting range is from 13.0V to 15.0V for 12V  FLV 27 130 <sup>BATT</sup> V



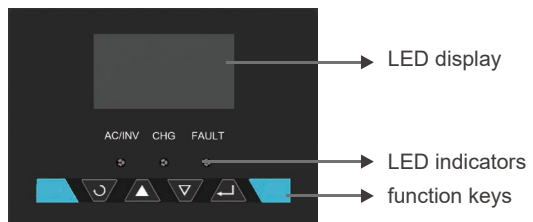

### ■ Display Panel

The operation and display panel, shown in chart below, is on the front panel of the inverter. It includes three indicators, four function keys and an LCD display, indicating status and input/output power information.



LED Indicator		Parameter	
AC/INV	Green	Solid	Output is powered by an AC source in line
		Flashing	Output is powered by battery or in invert mode
CHG	Green	Solid	Battery is fully charged
		Flashing	Battery is charging
FAULT	Red	Solid	Fault occurred
		Flashing	Warning conditions has occurred

### Function Keys





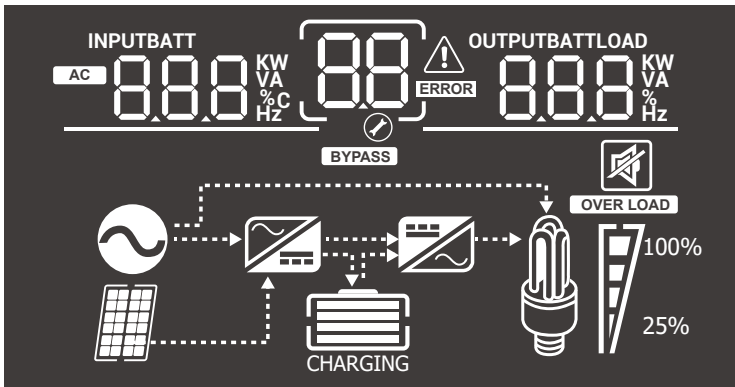



	Exit setting mode, go back
	Cycle through the menu
	Cycle through the menu
	1. Hold down to enter Parameter setting menu. 2. Press to confirm setting in parameter setting

### LCD Display Icons and Behaviors



**NOTE** some PCL inverter-chargers will differ in the LCD display on erroneous icons that do not influence or modify the working mode of the inverter-charger.



Icon	Function description																	
<b>Input Source Information</b>																		
	Indicates the AC input.																	
	Indicate input voltage, input frequency, battery voltage and charger current.																	
<b>Configuration Program and Fault Information</b>																		
	Indicates the setting programs.																	
	<p>Indicates the warning and fault codes.</p> <p>Warning:  flashing with warning code.</p> <p>Fault:  lighting with fault code</p>																	
<b>Output Information</b>																		
	Indicate output voltage, output frequency, load percent, load in VA, load in Watt and discharging current.																	
<b>Battery Information</b>																		
	Indicates battery level by 0-24%, 25-49%, 50-74% and 75-100% in battery mode and charging status in line mode.																	
In AC mode, it will present battery charging status.																		
<table border="1"> <thead> <tr> <th>Status</th> <th>Battery voltage</th> <th>LCD Display</th> </tr> </thead> <tbody> <tr> <td rowspan="3">Constant Current mode / Constant Voltage mode</td> <td>&lt;12.0V</td> <td>4 bars will flash in turns.</td> </tr> <tr> <td>12.0.V-12.5V</td> <td>Bottom bar will be on and the other three bars will flash in turns.</td> </tr> <tr> <td>12.5V-13.0V</td> <td>Bottom two bars will be on and the other two bars will flash in turns.</td> </tr> <tr> <td></td> <td>&gt;13.0V</td> <td>Bottom three bars will be on and the top bar will flash.</td> </tr> <tr> <td colspan="2">Floating mode. Batteries are fully charged.</td> <td>4 bars will be on.</td> </tr> </tbody> </table>	Status	Battery voltage	LCD Display	Constant Current mode / Constant Voltage mode	<12.0V	4 bars will flash in turns.	12.0.V-12.5V	Bottom bar will be on and the other three bars will flash in turns.	12.5V-13.0V	Bottom two bars will be on and the other two bars will flash in turns.		>13.0V	Bottom three bars will be on and the top bar will flash.	Floating mode. Batteries are fully charged.		4 bars will be on.		
Status	Battery voltage	LCD Display																
Constant Current mode / Constant Voltage mode	<12.0V	4 bars will flash in turns.																
	12.0.V-12.5V	Bottom bar will be on and the other three bars will flash in turns.																
	12.5V-13.0V	Bottom two bars will be on and the other two bars will flash in turns.																
	>13.0V	Bottom three bars will be on and the top bar will flash.																
Floating mode. Batteries are fully charged.		4 bars will be on.																

In battery mode, it will present battery capacity.

Load Percentage	Battery Voltage	LCD Display
Load >50%	<10.3V	
	10.3V ~ 10.8V	
	10.8V~11.3V	
	>11.3V	
50%> Load > 20%	<10.9V	
	10.9V ~ 11.4V	
	10.9V~11.9V	
	>11.9V	
Load < 20%	<11.2V	
	11.2V ~ 11.7V	
	11.7V~12.2V	
	>12.2V	

### Load Information

	Indicates overload.			
	Indicates the load level by 0-24%, 25-49%, 50-74% and 75-100%.			
	0%-24%	25%-49%	50%-74%	75%-100%

### Mode Operation Information

	Indicates unit is connected to shore power
	Indicates load is supplied by utility power.
	Indicates the utility charger circuit is working.
	Indicates the DC/AC inverter circuit is working.





### Mute Operation

	Indicates unit alarm is disabled.
--	-----------------------------------

# Programmable Features

The PCL inverter charger series is fully programmable. You may change the respective parameter by going to the Program Number listed below

## Function Keys

	Exit setting mode, go back to main menu
	Cycle through the menu
	Cycle through the menu
	1. Hold down to enter Parameter setting menu. 2. Tap to change/confirm setting in parameter setting menu

**NOTE**

When setting Frequency, Output Voltage, The Charge Current, and AC input voltage range, you must shut down the inverter charger completely for the changes to take effect

Setting Programs:

Program	Description	Selectable option
00	Exit setting mode	Escape 00 ESC

## 01 Utility Priority and Battery Priority

### Utility Priority

The default setting is Utility Priority (Ut1). Under this setting, once the inverter charger is connected to the utility, it will power the loads using the electricity from shore supply. The inverter charger will start charging the battery bank using the AC source, if necessary. In case of power outage, the system automatically switches to battery-powered mode.

### Battery Priority

The second setting is Battery Priority (SbU). Under this setting the inverter charger will provide power using the connected battery bank even when it detects an AC source. When the battery voltage reaches the low voltage set-point in Program 12, the inverter charger will power the loads using the connected AC source but will not charge the battery bank.

The following steps need to be taken to properly set the inverter charger to Battery Priority (SbU)

1. Press and hold the Enter key to enter the setting screen.
2. Press the down arrow key until setting 01 is shown.
3. Press and hold the Enter key until the setting starts flashing, press the up or down arrow key to select SbU. Press and hold the Enter key to save the setting.
4. Disconnect the inverter charger from the AC source/shore power.
5. Turn off the inverter charger, wait 10 seconds then turn it back on.

Taking these steps will set the inverter charger to Battery Priority (SbU)

01	Output source priority:To configure load powersource priority	Utility first (default) 01 UTI	Utility will provide power to the loads as first priority. Battery will provide power to the loads only when utility power is not available.
		Battery priority 01 SbU	Battery provides power to the loads as first priority. Utility provides power to the loads only when battery voltage drops to either low-level warning voltage or the setting point in program 12.

### 03 AC Input Voltage Range



By default, the PCL inverters are set to a narrow input voltage range for which the inverter charger will work in Utility mode and then switch to backup mode. It is recommended to keep in this mode if connecting sensitive electronic appliances like computers, TVs etc. as narrow mode reduces the switch over time from external power source to batteries backup.

Selecting a wide input voltage range is recommended when you need power and might be running a generator as they tend to have wider tolerance for a disturbed waveform or are having issues with the stability of the main utility line. This will have a wider range to prevent switching to backup battery mode if utility power is within the wider range.

03	Input voltage range	03 APL Wide Utility effective range: Nominal output voltage: -23% to +15%
		03 UPS Narrow (default) Utility effective range: Nominal output voltage: -15% to +15%



## 04 Power Saving Mode

Power saver function is designed to conserve battery power when AC power is not or rarely required by the loads. In this mode, the inverter pulses the AC output looking for an AC load (i.e., electrical appliance). Whenever an AC load (greater than 50 watts) is turned on, the inverter recognizes the need for power and automatically starts inverting and output goes to full voltage. When there is no load (or less than 50 watts) detected, the inverter automatically goes back into search mode to minimize energy consumption from the battery bank. In “Power saver on” mode, the inverter will draw power mainly in sensing moments, thus the idle consumption is significantly reduced.

04	Power saving mode enable/disable	Saving mode disable (default) 	If disabled, inverter output will be available at all times.
		Saving mode enable 	If enabled, output of the inverter will be off until a load greater than 50 watts is detected.

## 09 Output Frequency

The factory default frequency for inverters is 60Hz. Normally, manufacturers build electrical devices for a certain amount of Current, Voltage and Hertz (Cycles) which is mentioned on the name plate. The Current is dependent of the Voltage and the Hertz supplied to an electric motor or appliance.

09	Output frequency	50Hz 	60Hz (default) 
----	------------------	---	---

## 11 Maximum Utility Charging

The PCL inverter chargers can operate like battery chargers converting incoming AC power into DC recharging power. The 2000W has a 65A max while the 3000W has a 75A max adjustable battery charging.

11	Maximum utility charging current		The default is the maximum value (65A-2KW, 75A-3KW), with a 5A minimum.
----	----------------------------------	---	---

## 12 Low Battery Voltage Setpoint

The purpose of this setpoint is to protect the batteries from being over discharged. It assumes that Battery Priority is set on Program 01. If utility power is not available, the designated setpoint will cut of all working loads. Upon Utility power being detected, the Utility power/Generator will then power the loads.

12	Low battery voltage inverter transfer to Utility		The default is low battery voltage alarm set point. The range is from 10.5V to 12.5V.if the voltage set by user is below default point ,the default is low battery voltage alarm point. Increment of each click is 0.1V for 12V
----	--	---	---

## 13 Over-Voltage Battery Recovery

This setpoint indicates the recovery voltage to normal operation when a battery has been over-charged or is over the voltage limit. The inverter charger will be in a fault state if the battery voltage is above this designated setpoint and resume normal battery operation when reaching this set point.

13	Over-voltage battery recovery		Over-voltage battery recovery can be set between 13.0V to 15.5V. otherwise it is output of bypass setting range is from 13.0Vto 15.5Vfor 12V,if the voltage set by user Increment of each click is 0.1V for 12V
----	-------------------------------	---	---

## 18 Key sound control

It is used to control the sound of the key. When the key is on, it can make a sound by pressing the key. When it is off, there is no sound by pressing the key.

18	Beeps while function keys are pressed	on 18 b0N	off 18 b0F
----	---------------------------------------	--------------	---------------

## 19 Screen Mode

By default, after 1 minute of inactivity, the inverter charger will return to the first screen that is seen when first powering on the unit. Users can change this mode to continue viewing the last screen they left on before inactivity.

19	Auto return to default display screen	Return to default display screen (default) 19 ESP	If selected display screen will return to default screen (Input voltage/ Output voltage) after 1 minute of inactivity.
		Stay at latest screen 19 LEP	Display screen will stay on current screen until user changes it.

## 20 LCD Screen Mode

The LCD display on the inverter chargers will stay on by default. Users may toggle this switch to have the screen turn off after inactivity.

20	LCD Screen Control	LCD screen will stay on indefinitely.(default) 20 LON	LCD screen will turn off after inactivity. 20 LOF
----	--------------------	--	--

## 22 The mains switches to inverter sound

When the switch is on and the inverter's main input AC power is disconnected, the inverter will sound an alarm. When the switch is off, no more alarms are raised.

22	Beeps while primary source is interrupted	on 22 AON	off 22 AOF
----	---	--------------	---------------

## 25 Record Fault Code

The PCL inverter will demonstrate the fault code.

25	Record Fault code	Record enable	Record disable (default)
		25 FEN	25 Fds

## 26 Boost Charging

Refer to Program 5 for modifying this setting.

**NOTE** This setting will not be modifiable if users choose a pre-set battery voltage.

26	Bulk charging voltage(C.V voltage)	If User-defined is selected in program94,this program can be set up.Setting range is from program 94
	EU	EU 26 130 <sup>BATT</sup> V
	Maximum charging voltage for Lithium battery. When the voltage reaches the set voltage, charging will stop.	If User-defined is selected in program 94,this program can be set the maximum charging voltage. Setting range is from 13.0V-15.5V
	EOE	EOE 26 130 <sup>BATT</sup> V

## 27 Float Charging

Refer to Program 5 for modifying this setting.

**NOTE** This setting will not be modifiable if users choose a pre-set battery voltage.

27	Floating charging voltage	If User-defined is selected in program 94,this program can be set up.Setting range is from 13.0V to 15.0V for 12V
	FLU	FLU 27 130 <sup>BATT</sup> V
	Battery low voltage open charging(for lithium battery)	If User-defined is selected in program 94,this program can be set up.Setting range is from 12.0V to 14.0V for 12V
	LC	LC 27 120 <sup>BATT</sup> V

## 29 Low DC Cut-off Voltage

This program determines the cut-off voltage range for the PCL inverter charger battery input. Upon reaching this voltage, the PCL inverter will cut off operation until the battery can go above this voltage level.

**NOTE** This value must be lower than Program 98: Low Battery Voltage Warning



29	Low DC cut-off voltage	<p>The default setting is 10.0V. Setting range is from 10.0V to 12.0V with increments of 0.1V. This setting must be at least 0.5V lower than setting #98 Low Battery Alarm.</p> <p style="text-align: center;">  </p>
----	------------------------	--



## ■ 92 AC Input Voltage Range (AC230V output inverter to have this function)

Item 92 takes effect only when the user selects "UPS" in item 03. 03 project has two options, is to select the width of the input voltage range, mainly the input voltage lower limit is different. In UPS mode, when the input range is narrow, the user can set the lower voltage limit by himself. 1V is the first gear.

In the AC230V output inverter will have 92 items, AC120V output inverter does not have this function

## ■ 93 Input Frequency Range



The factory default frequency for inverters is 60Hz. Normally, manufacturers build electrical devices for a certain amount of Current, Voltage and Hertz (Cycles) which is mentioned on the name plate. The Current is dependent of the Voltage and the Hertz supplied to an electric motor or appliance. This program allows you to set the frequency range of the AC input source. Special cases might require a wider frequency range than normal Utility and Generator outputs.

93	Frequency Range	Special 40-70HZ 
		General 50HZ 45-55HZ / 60HZ 55-65HZ 

## ■ 94 Selection of Battery Type Custom

Refer to Program 5 for modifying this setting.

**NOTE** This setting will not be modifiable if users choose a pre-set battery voltage.

94	Selection of battery type	Lithium battery 	If selected, battery charge voltage and battery low open charging can be set up in program 26,27
		Other battery 	If selected ,battery charge voltage can be set up in program 26,27

## ■ 95 Battery High Voltage for Dry Contacts

The PCL inverter charger series have functions to automatically start and stop a generator for supplementing charge. The Auto Generator feature starts the Generator with the use of Normally Closed (NC) contacts of the relay that “opens” when the battery voltage drops to the programmed value of Program 96, Low Battery Voltage Set-point. The Normally Open (NO) relay “closes”, and the auto generator start commences the generator to start charging the battery bank. When the battery is recharged and its voltage rises to the programmed value of Program 95, High Battery Voltage Set-point The NC (closes) contacts and NO (open) contacts of relay reset and the Generator will stop / shut down the Generator automatically. The PCL unit will then transfer back to “Inverting Mode”.

95	Battery high voltage trip	<p>When dry contact switch from NC to NO, battery voltage arrive to setting voltage, dry contact point switch to NC. This setting can not be than fast charge voltage.higher setting range is from 13.0V to 15.5V for 12V Increment of each click is 0.1V for 12V</p> 
----	---------------------------	---



## ■ 96 Low Voltage Trip for Dry Contacts

The PCL inverter charger series have functions to automatically start and stop a generator for supplementing charge. The Auto Generator feature starts the Generator with the use of Normally Closed (NC) contacts of the relay that “opens” when the battery voltage drops to the programmed value of Program 96, Low Battery Voltage Set-point. The Normally Open (NO) relay “closes”, and the auto generator start commences the generator to start charging the battery bank. When the battery is recharged and its voltage rises to the programmed value of Program 95, High Battery Voltage Set-point The NC (closes) contacts and NO (open) contacts of relay reset and the Generator will stop / shut down the Generator automatically. The PCL unit will then transfer back to “Inverting Mode”.

96	Battery low voltage trip	<p>When battery voltage arrive to Setting point, the dry contact switch from NC to NO. This setting can not be lower than low battery voltage cut off point. setting range is from 10.5V to 12.5Vfor 12V Increment of each click is 0.1V for 12V</p> 
----	--------------------------	--

## ■ 97 Dry Contact Control

To modify battery set-points in Program 95 and Program 96, The dry contacts control needs to be enabled. This allows control over the auto generator function.

97	Dry contact control	<p>If inverter is set in dcd, dry contact function is disable, ,96 can not be set up in program.95</p> 
		<p>If inverter is set in dce, dry contact function is enable and 95,96 can be set up in program.</p> 

## ■ 98 Low Battery Voltage Alarm

Users can select to have the PCL inverter-charger sound an alarm at a programmable battery voltage. This will need to be a higher value than Program 29 Low DC Cut-off Voltage as it will warn users that the battery is discharging before ultimately disconnecting.

98	Low voltage battery alarm	<p>The default is 10.5V. The setting range is 10.5V-12.5V with increments of 0.1V. This setting will be at least 0.5V greater than setting #29</p> 
----	---------------------------	---

## ■ 99 AC output Voltage

Allows users to customize AC output voltages for devices that might need to meet a very specific AC powering criteria.

99	AC output voltage	<p>The default is 120V, can be set between 100V-120V with increments of 5V</p> 
----	-------------------	--

# Battery Charging Stages

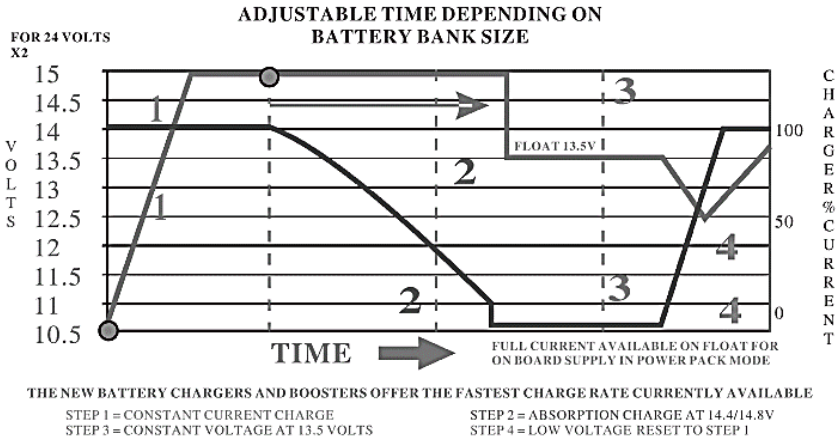

**Bulk Stage:** The charger will supply constant current until the battery voltage reaches the boost voltage. The software will calculate the time charging began up until the battery voltage reaches 0.3V below the boost voltage. It uses this time to as  $T_0$  and  $T_0 \times 10 = T_1$ .

**Boost Stage:** The charger will supply constant voltage and reduce the current slowly through this stage. The charger will stay in this stage until  $T_1$  has run out. After this time the charger will enter the float stage. This stage will last between 1 hour and 12 hours depending on  $T_1$ .

**NOTE** the stage period is determined by internal software







**Float Stage:** During this stage the charger will supply a constant voltage which is determined by the battery selected and will keep current at a minimum. This stage acts as a trickle charger.

**Equalization:** This stage is only available if the battery selector is switched to position 8. During this stage the batteries are charged at a higher voltage than normal and for most batteries this could cause damage. Please refer to the batteries owner's manual or contact the manufacturer to see if this stage is needed.

## Fault / Warning Codes







**NOTE**

The following fault codes will have a caution symbol when experiencing the fault

Warning Code	Warning Event	Icon On
03	Battery over voltage	
04	Battery low voltage	
05	Inverter over temperature	
07	Inverter overload	
88	Transformer phase reversal	
89	Frequency is out of range	

**NOTE**

The following will experience an error display as well as the fault code

Fault Code	Fault Event	Icon on
02	Heat sink over temperature	
03	Battery voltage is too high	
04	Battery voltage is too low	
05	Output short circuit	
06	Output is too high or too low	
07	Overload	
99	Inverter fail to slow start	

## Technical Specifications

Model	R-INV-T-PCL1-20111S	R-INV-T-PCL1-20123S	R-INV-T-PCL1-30111S	R-INV-T-PCL1-30123S
<b>Inverter Specification</b>				
Rated Output Power	2000W		3000W	
Surge Power (1 second)	6000W		9000W	
Surge Power (3 seconds)	3000W		4500W	
Surge Power (10 seconds)	2400W		3600W	
Nominal output Voltage RMS	120VAC(100~120VAC, 5V intervals) 230VAC(200~240VAC, 10V intervals)			
Output Frequency	50Hz $\pm$ 0.3Hz or 60Hz $\pm$ 0.3Hz			
Output Wave Form	Pure Sine Wave			
Output Overload	105% < Load < 120% $\pm$ 10% : Fault ( Turn off output after 10 seconds) 120% < Load < 150% $\pm$ 10% : Fault ( Turn off output after 3 seconds) 150% < Load $\pm$ 10% : Fault ( Turn off output after 1 seconds)			
Nominal Input Voltage	12 VDC			
Input Voltage Range	10~ 16 VDC $\pm$ 0.3 VDC			
Low DC Warning Voltage	10.5 VDC $\pm$ 0.3 VDC			
Low DC Cut-off Voltage	10 VDC $\pm$ 0.3 VDC			
Short Circuit Protection	Software Protection			
Nominal Efficiency	> 90% Peak			
No load power Consumption	Normal:<20W Power Saving:<15W		Normal:<30W Power Saving:<15W	

<b>Charger Specifications</b>				
Nominal Input Voltage	120VAC/230VAC			
Input Voltage Range	90-138 VAC/155-275VAC			
Input Frequency Range	40Hz - 70Hz			
Input Wave Form	Sine Wave ( Utility or Generator )			
Power Factor	0.9 - 1			
Optimal Efficiency	>85%			
Output Current	5-65A		5-75A	
	Configurable, 5A intervals			
Short Circuit Protection	Circuit Breaker			
Output Overload	120% < Load < 150% $\pm$ 10% : Fault ( Turn off output after 60 seconds) 150% < Load $\pm$ 10% : Fault ( Turn off output after 1 second)			
Over Charge Protection Shutdown	16.0V for 12VDC			





Transfer Switch Specifications		
Transfer Time	~ 10ms	
Line Mode Efficiency	> 95%	
Transfer Relay Rating	20A Maximum Bypass	30A Maximum Bypass

Wired remote control	
List dimensions	2.8 x 4.3 x 1.3 in / 70 x 110 x 31.8 mm
Wire length	Approx 16.4ft

General Specifications		
Battery Types	GEL, AGM, SLA, FLD, CAL, LI, USER	
Operating Temperature Range	0~40°C/0~104°F	
Storage Temperature	-30~70°C/-22~158°F	
Humidity	0% ~ 95%	
Noise	<50dB	
Dimensions	510 x 285 x 193 mm / 20.1 x 11.2 x 7.6 in	
Weight	51.1 lbs / 23.2 Kg	63.5 lbs / 28.8 Kg
Certifications	ETL listed to CSA Standard C22.2 No. 107.1 and UL458 with marine supplement	

\*Product specifications are subject to change without further notice

Renogy reserves the right to change the contents of this manual without notice.



**US** |  2775 E Philadelphia St, Ontario, CA 91761, USA  
 909-287-7111  
 [www.renogy.com](https://www.renogy.com)  
 [support@renogy.com](mailto:support@renogy.com)

**CN** |  苏州高新区科技城培源路1号5号楼-4  
 400-6636-695  
 <https://www.renogy.cn>  
 [support@renogy.cn](mailto:support@renogy.cn)

**JP** |  <https://www.renogy.jp>  
 [supportjp@renogy.com](mailto:supportjp@renogy.com)

**CA** |  <https://ca.renogy.com>  
 [supportca@renogy.com](mailto:supportca@renogy.com)

**AU** |  <https://au.renogy.com>  
 [supportau@renogy.com](mailto:supportau@renogy.com)

**UK** |  <https://uk.renogy.com>  
 [supportuk@renogy.com](mailto:supportuk@renogy.com)

**DE** |  <https://de.renogy.com>  
 [supportde@renogy.com](mailto:supportde@renogy.com)