

ADVENTURER

30A PWM

Flush Mount Charge Controller w/ LCD Display



Version 2.0



Important Safety Instructions

Please save these instructions.

This manual contains important safety, installation, and operating instructions for the charge controller. The following symbols are used throughout the manual:

- | | |
|--------------------------------------------------------------------------------------------------|---------------------------------------------------------------------------------------------------------|
|  WARNING | Indicates a potentially dangerous condition. Use extreme caution when performing this task. |
|  CAUTION | Indicates a critical procedure for safe and proper operation of the controller. |
|  NOTE | Indicates a procedure or function that is important to the safe and proper operation of the controller. |

General Safety Information

- Read all of the instructions and cautions in the manual before beginning the installation.
- There are no serviceable parts for this controller. Do **NOT** disassemble or attempt to repair the controller.
- Make sure all connections going into and from the controller are tight. There may be sparks when making connections, therefore, make sure there are not flammable materials or gases near installation.

Charge Controller Safety

- **NEVER** connect the solar panel array to the controller without a battery. Battery must be connected first. This may cause a dangerous occurrence where the controller would experience a high open circuit voltage at the terminals.
- Ensure input voltage does not exceed **50 VDC** to prevent permanent damage. Use the Open Circuit (Voc) to make sure the voltage does not exceed this value when connecting panels together in series.
- The charge controller should be installed indoors in a well-ventilated, cool, and dry environment.
- Do **NOT** allow water to enter the controller.

■ Battery Safety

- Do **NOT** let the positive (+) and negative (-) terminals of the battery touch each other.
- Explosive battery gases may be present while charging. Be certain there is enough ventilation to release the gases.
- Be careful when working with large lead acid batteries. Wear eye protection and have fresh water available in case there is contact with the battery acid.
- Over-charging and excessive gas precipitation may damage the battery plates and activate material shedding on them. Too high of an equalizing charge or too long of one may cause damage. Please carefully review the specific requirements of the battery used in the system.
- Equalization is carried out only for non-sealed / vented / flooded / wet cell lead acid batteries.
- Do NOT equalize VRLA type AGM / Gel / Lithium cell batteries UNLESS permitted by battery manufacturer.

WARNING

Connect battery terminals to the charge controller **BEFORE** connecting the solar panel(s) to the charge controller. **NEVER** connect solar panels to charge controller until the battery is connected.

Once equalization is active in the battery charging, it will not exit this stage unless there is adequate charging current from the solar panel. There should be **NO** load on the batteries when in equalization charging stage.

Table of Contents

General Information	04
Product Overview	05
Identification of Parts	05
Dimensions	06
Included Components	07
Optional Components	07
Installation	08
Flush Mounting	09
Surface Mount Attachment	10
Wiring	10
Operation	12
System Status Icons	13
Change the Parameters	13
Power Generation Interface -> Reset	13
Battery Interface -> Set Battery Type	13
Battery Temperature Interface -> Change from C° to F°	14
Set Battery Type to Lithium -> Set Lithium Parameters	14
Lithium Battery Activation	14
PWM Technology	15
Four Charging Stages	15
System Status Troubleshooting	16
Maintenance	17
Fusing	17
Technical Specifications	18
Battery Charging Parameters	18

General Information

The Adventurer is an advanced charge controller for off-grid solar applications. Integrating highly efficient PWM charging, this controller increases battery life and improved system performance. It can be used for 12V or 24V battery or battery bank. The controller is embedded with self-diagnostics and electronic protection functions that prevent damages from installation mistakes or system faults.

Key Features

- Automatic recognition for 12V or 24V system voltage.
- 30A charging capacity.
- Backlit LCD screen for displaying system operating information and data.
- Compatible with AGM, Sealed, Gel, Flooded, and Lithium batteries.
- 4 Stage PWM charging: Bulk, Boost, Float, and Equalization.
- Temperature compensation and correcting the charging and discharging parameters automatically, improving battery lifetime.
- Protection against: overcharging, over current, short-circuit, and reverse polarity.
- Unique USB port on the front display.
- Integrated communication port for remote monitoring
- Charges over-discharged lithium iron-phosphate batteries
- Specifically designed for RV application and allows for aesthetically clean flush mounting on walls.
- Remote temperature compensation compatible.
- Remote battery voltage sensor compatible.

Product Overview

Identification of Parts

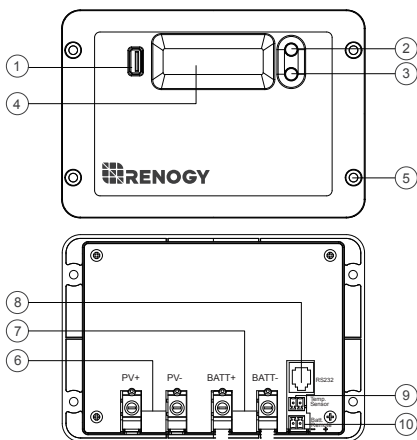

#	Label	Description
1	USB Port	5V, Up to 2.4A USB port for charging USB devices.
2	Select Button	Cycle through the interface
3	Enter Button	Parameter Setting button
4	LCD Display	Blue Backlit LCD displays system status information
5	Mounting Holes	diameter holes for mounting the controller
6	PV Terminals	Positive and Negative PV Terminals
7	Battery Terminals	Positive and Negative Battery Terminals
8	RS232 Port	Communication port for connecting monitoring accessories such as Bluetooth, requires a separate purchase.
9	Temperature Sensor Port	Battery Temperature Sensor port utilizing data for accurate temperature compensation and charge voltage adjustment.
10	BVS	Battery Voltage Sensor port for measuring the battery voltage accurately with longer line runs.

■ Dimensions

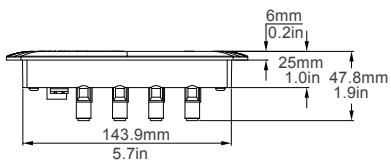
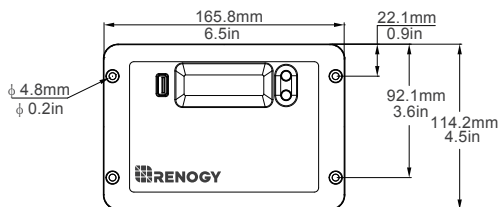

Adventurer Controller

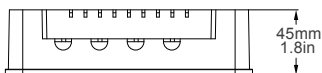
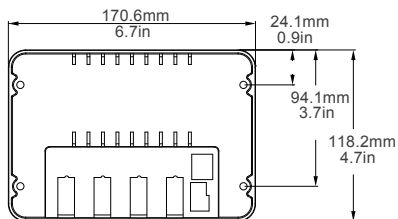

Adventurer Accessory

■ Included Components

Adventurer Surface Mount Attachment



The Renogy Adventurer Surface Mount will give you the option to mount the charge controller to any flat surface; circumventing the flush mount option.

NOTE Screws included for the attachment
Screws are included for flush mounting.

■ Optional Components

These components are not included and require a separate purchase.

Remote Temperature Sensor:



This sensor measures the temperature at the battery and uses this data for very accurate temperature compensation. Accurate temperature compensation is important in ensuring proper battery charging regardless of the temperature.

NOTE Do Not use this sensor when charging lithium battery.

Battery Voltage Sensor (BVS):



The battery voltage sensor is polarity sensitive and should be used if the adventurer will be installed with longer line runs. In longer runs, due to connection and cable resistance, there can be discrepancies in the voltages at the battery terminals. The BVS will make sure the voltage is always correct to ensure the most efficient charging.

Renogy BT-1 Bluetooth Module:



The BT-1 Bluetooth module is a great addition to any Renogy charge controllers with a RS232 port and is used to pair charge controllers with the Renogy BT App. After pairing is done you can monitor your system and change parameters directly from you cell phone or tablet. No more wondering how your system is performing, now you can see performance in real time without the need of checking on the controller's LCD.

Renogy DM-1 4G Data Module:



The DM-1 4G Module is capable of connecting to select Renogy charge controllers through an RS232, and is used to pair charge controllers with Renogy 4G monitoring app. This app allows you to conveniently monitor your system and charge syeters parameters remotely from anywhere 4G LTE network service is available.

Installation

WARNING

Connect battery terminal wires to the charge controller FIRST then connect the solar panel(s) to the charge controller. NEVER connect solar panel to charge controller before the battery.

CAUTION

Do not over tighten the screw terminals. This could potentially break the piece that holds the wire to the charge controller.

Refer to the technical specifications for max wire sizes on the controller and for the maximum amperage going through wires.

Mounting Recommendations:

WARNING

Never install the controller in a sealed enclosure with flooded batteries. Gas can accumulate and there is a risk of explosion.

The Adventurer is designed for flush mounting on a wall. It consists of a face plate with projecting terminals on the backside for connecting the battery bank, panels, and optional sensors for accurate battery voltage sensing and battery temperature compensation. If utilizing the wall mount, then the wall will be required to be cut to accommodate the projecting terminals on the backside. Make sure that the pocket of the wall cut leaves enough space to not damage the terminals when the Adventurer is being pushed back into the cut out section of the wall.

The front of the Adventurer will serve as a heat sink, therefore it is important to ensure that the mounting location is not near any heat generating sources and ensure that there is proper airflow across the faceplate of the Adventurer to remove the heat dissipated from the surface.

1. **Choose Mounting Location**—place the controller on a vertical surface protected from direct sunlight, high temperatures, and water. Make sure there is good ventilation.
2. **Check for Clearance**—verify that there is sufficient room to run wires, as well as clearance above and below the controller for ventilation. The clearance should be at least 6 inches (150mm).
3. **Cut out Wall section**—the recommended wall size to be cut should follow the inner protruding part of the charge controller while being careful not to go past the mounting holes. The depth should be at least 1.7 inches (43mm).
4. **Mark Holes**
5. **Drill Holes**

NOTE

The Adventurer comes equipped with screws for wall mounting. If they are not suitable try using Pan Head Phillips Screw 18-8 Stainless Steel M3.9 Size 25mm length screws

6. **Secure the charge controller.**

■ Flush Mounting:

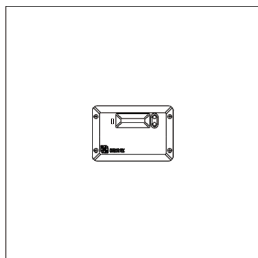
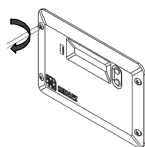
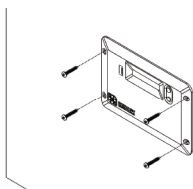
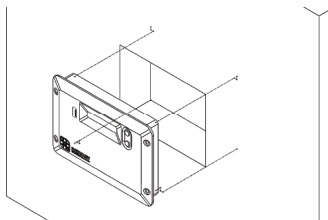
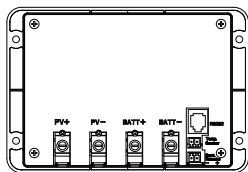

■ Surface Mount Attachment:

The charge controller can also be mounted on a flat surface using the Adventurer Surface Mount Attachment. In order to properly mount the charge controller, there is no need to cut a section of the wall considering the charge controller can now be mounted on a flat surface using the attachment. Mark and drill holes using the four pan head Phillips screws that are provided specifically for the surface mount option.

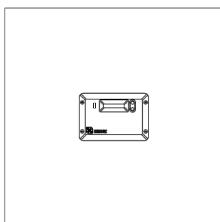
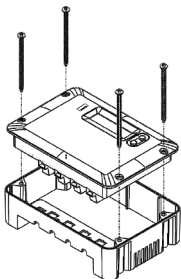

Wiring

1. Unscrew battery terminals by rotating counterclockwise to open the hatch. Then connect the positive and negative battery connections in their appropriate labeled terminal. The controller will turn on upon successful connection.

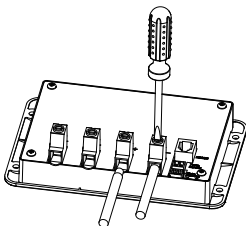
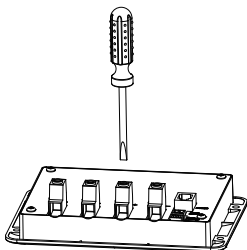

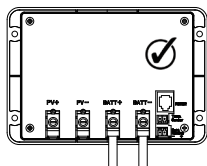
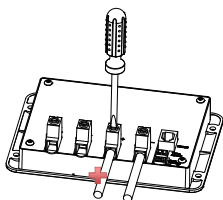

2. Unscrew PV terminals by rotating counterclockwise to open the hatch. Then connect the positive and negative battery connections in their appropriate labeled terminal.

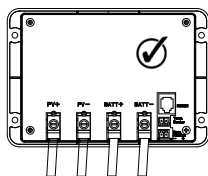
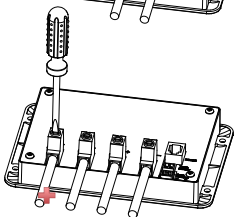
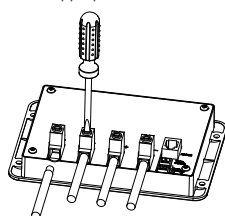
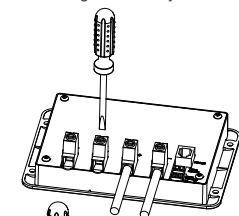

3. Insert temperature sensor block terminal and connect wire. It is not polarity sensitive. (Optional, requires a separate purchase).

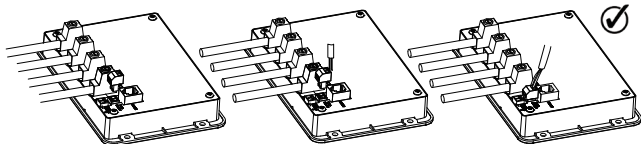

4. Insert the battery voltage sensor terminal block in the Batt Remote port. This is polarity sensitive. (Optional, requires a separate purchase).

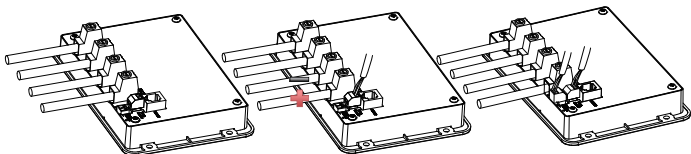





WARNING



If unscrewing the Battery Voltage Sensor terminal block, make sure to not mix the wires. It is polarity sensitive and may cause damage to the controller if connected incorrectly.

Operation





After connecting the battery to the charge controller, the controller will turn on automatically. Assuming normal operation, the charge controller will cycle through different display. They are as follows:

Parameter	Display
PV Array Voltage	 0.0^V
Charging Current	 0.0^A
Generated Energy	 0.0^{kWh}
Battery Voltage	 0.0^V
Temperature	 0.0^{F°}

The Adventurer is an easy to use controller requiring minimal maintenance. The user is able to adjust some parameters based on the display screen. The user can manually cycle through the display screens by using the “SELECT” and “ENTER” buttons

 SELECT  ENTER	<p>Cycles forwards through the different display screens.</p> <p>Cycles backwards through the different select screens & Customize some parameters on the charge controller</p>
---------------------------------------------------------------------------------------------------------------------------------------------------------------------------------------------------	--------------------------------------------------------------------------------------------------------------------------------------------------------------------------------------------------

System Status Icons

Icon	Behavior
	<p>Constant: System is normal, but it is not charging.</p> <p>Charging: The bars will be sequencing indicating the system is charging.</p>
	<p>Constant: The battery is at full charge.</p> <p>Flashing: The battery is overvoltage.</p>
	<p>Flashing: The battery is under voltage.</p>
	<p>Flashing: The bars are sequencing, indicating the controller is activating over-discharged lithium battery.</p>
	<p>Constant: System is abnormal.</p>

Change the Parameters

Simply hold the “ENTER” button for approximately 5 seconds until the display flashes. Once flashing, then press “SELECT” until the desired parameter is reached and press “ENTER” one more time to lock in the parameter.

NOTE The screen must be at the appropriate interface in order to change the specific parameter.

1. Power Generation Interface → Reset

The user is able to reset the current power generation (kWh) back to 0 kWh.



2. Battery Interface → Set Battery Type

In this interface, the user is able to select which type of battery is connected to the charge controller. Choose from Sealed, Gel, or Flooded batteries.



3. Battery Temperature Interface → Change from C° to F°

The user can select between displaying battery temperature in Celsius or Fahrenheit.



4. Set Battery Type to Lithium → Set Lithium Battery Parameters

When using the Adventurer to charge lithium battery, the user is able to set Battery Parameters. In the Battery Interface, select Lithium as Battery Type. Short press "ENTER" to enter Battery Voltage selection interface.

Press "SELECT" to select the Battery Voltage. Press "ENTER" to confirm selection and go to Charging Parameters Interface.

Press "SELECT" to change the Boost Voltage. The default setting is 14.2V and the user is able to set it in the range 12.6~16.0V, with a step of 0.2V. Hold "ENTER" to confirm the selection. The setting will also be automatically saved after 15 seconds without holding "ENTER".



NOTE

The above settings are only available under Lithium Battery type.

Lithium Battery Activation

The Adventurer PWM charge controller has a reactivation feature to awaken a sleeping lithium battery. The protection circuit of Li-ion battery will typically turn the battery off and make it unusable if over-discharged. This can happen when storing a Li-ion pack in a discharged state for any length of time as self-discharge would gradually deplete the remaining charge. Without the wake-up feature to reactivate and recharge batteries, these batteries would become unserviceable and the packs would be discarded. The Adventurer will apply a small charge current to activate the protection circuit and if a correct cell voltage can be reached, it starts a normal charge.

CAUTION

When using the Adventurer to charge a 24V lithium battery bank, set the system voltage to 24V instead of auto recognition. Otherwise, the over-discharged 24V lithium battery wouldn't be activated.

PWM Technology

The Adventurer utilizes Pulse Width Modulation (PWM) technology for battery charging. Battery charging is a current based process so controlling the current will control the battery voltage. For the most accurate return of capacity, and for the prevention of excessive gassing pressure, the battery is required to be controlled by specified voltage regulation set points for Absorption, Float, and Equalization charging stages. The charge controller uses automatic duty cycle conversion, creating pulses of current to charge the battery. The duty cycle is proportional to the difference between the sensed battery voltage and the specified voltage regulation set point. Once the battery reached the specified voltage range, pulse current charging mode allows the battery to react and allows for an acceptable rate of charge for the battery level.

Four Charging Stages

The Adventurer has a 4-stage battery charging algorithm for a rapid, efficient, and safe battery charging. They include: Bulk Charge, Boost Charge, Float Charge, and Equalization.

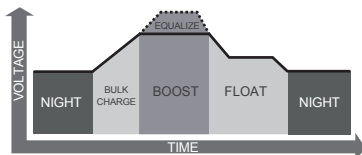

Bulk Charge: This algorithm is used for day to day charging. It uses 100% of available solar power to recharge the battery and is equivalent to constant current.

Boost Charge: When the battery has charged to the Boost voltage set-point, it undergoes an absorption stage which is equivalent to constant voltage regulation to prevent heating and excessive gassing in the battery. The Boost time is 120 minutes.

Float Charge: After Boost Charge, the controller will reduce the battery voltage to a float voltage set point. Once the battery is fully charged, there will be no more chemical reactions and all the charge current would turn into heat or gas. Because of this, the charge controller will reduce the voltage charge to smaller quantity, while lightly charging the battery. The purpose for this is to offset the power consumption while maintaining a full battery storage capacity. In the event that a load drawn from the battery exceeds the charge current, the controller will no longer be able to maintain the battery to a Float set point and the controller will end the float charge stage and refer back to bulk charging.

Equalization: Is carried out every 28 days of the month. It is intentional overcharging of the battery for a controlled period of time. Certain types of batteries benefit from periodic equalizing charge, which can stir the electrolyte, balance battery voltage and complete chemical reaction. Equalizing charge increases the battery voltage, higher than the standard complement voltage, which gasifies the battery electrolyte.





Once equalization is active in the battery charging, it will not exit this stage unless there is adequate charging current from the solar panel. There should be NO load on the batteries when in equalization charging stage.



Over-charging and excessive gas precipitation may damage the battery plates and activate material shedding on them. Too high of equalizing charge or for too long may cause damage. Please carefully review the specific requirements of the battery used in the system.

System Status Troubleshooting

Indicator	Description	Troubleshoot
 Flashing	Battery over voltage	Use a multi-meter to check the voltage of the battery. Make sure the battery voltage is not exceeding the rated specification of the charge controller. Disconnect battery.
 Flashing	Battery under voltage	Use a multi-meter to verify the rated battery voltage. Disconnect any loads connected to the battery to allow it to charge.
Other Considerations		
Charge controller does not charge during daytime when the sun is shining on the solar panels.		Confirm that there is a tight and correct connection from the battery bank to the charge controller and the solar panels to the charge controller. Use a multi-meter to check if the polarity of the solar modules have been reversed on the charge controller's solar terminals.
Everything is connected correctly, but the LCD on the controller does not turn on		Check the rated battery voltage. The LCD will not display on the charge controller unless there is at least 9V coming from the battery bank.

Error Codes

Error Number	Description
E0	No error detected
E01	Battery over-discharged
E02	Battery over-voltage
E06	Controller over-temperature
E07	Battery over-temperature
E08	PV input over-current
E10	PV over-voltage
E13	PV reverse polarity
E14	Battery reverse polarity

Maintenance

For best controller performance, it is recommended that these tasks be performed from time to time.

1. Check that controller is mounted in a clean, dry, and ventilated area.
2. Check wiring going into the charge controller and make sure there is no wire damage or wear.
3. Tighten all terminals and inspect any loose, broken, or burnt up connections.

Fusing

Fusing is a recommendation in PV systems to provide a safety measure for connections going from panel to controller and controller to battery. Remember to always use the recommended wire gauge size based on the PV system and the controller.

NEC Maximum Current for different Copper Wire Sizes									
AWG	16	14	12	10	8	6	4	2	0
Max. Current	10A	15A	20A	30A	55A	75A	95A	130A	170A

Fuse from Controller to Battery

Controller to Battery Fuse = Current Rating of Charge Controller

Ex. Adventurer = 30A fuse from Controller to Battery

Fuse from Solar Panel(s) to Controller

Ex. 200W; 2 X 100 W panels

Parallel

Total Amperage = $I_{sc1} + I_{sc2} = (5.75A + 5.75A) * 1.25$

Fuse = minimum of $11.5 * 1.25 = 14.38 = \underline{15A \text{ fuse}}$

Technical Specifications

Description	Parameter
Nominal Voltage	12V/24V Auto Recognition
Rated Charge Current	30A
Max. PV Input Voltage	50 VDC
USB Output	5V, 2.4A max
Self-consumption	≤13mA
Temperature Compensation Coefficient	-3mV/ C/2V
Operating Temperature	-25°C to +55°C -13°F to 131°F
Storage Temperature	-35°C to +80°C -31°F to 176°F
Enclosure	IP20
Terminals	Up to # 8AWG
Weight	0.6 lbs / 272g
Dimensions	6.56 x 4.50 x 1.90 in / 167 x 114 x 48 mm
Communication	RS232
Battery Type	Sealed (AGM), Gel, Flooded, and Lithium

Battery Charging Parameters

Battery	GEL	SLD/ AGM	FLOODED	LITHIUM
High Voltage Disconnect	16 V	16 V	16 V	16 V
Charging Limit Voltage	15.5 V	15.5 V	15.5 V	15.5 V
Over Voltage Reconnect	15 V	15 V	15 V	15 V
Equalization Voltage	----	----	14.8 V	----
Boost Voltage	14.2 V	14.6 V	14.6 V	14.2 V (User: 12.6-16 V)
Float Voltage	13.8 V	13.8 V	13.8 V	----
Boost Return Voltage	13.2 V	13.2 V	13.2 V	13.2 V
Low Voltage Reconnect	12.6 V	12.6 V	12.6 V	12.6 V
Under Voltage Recover	12.2 V	12.2 V	12.2 V	12.2 V
Under Voltage Warning	12V	12V	12V	12V
Low Voltage Disconnect	11.1 V	11.1 V	11.1 V	11.1 V
Discharging Limit Voltage	10.8 V	10.8 V	10.8 V	10.8 V
Equalization Duration	----	----	2 hours	----
Boost Duration	2 hours	2 hours	2 hours	----

Renogy reserves the right to change the contents of this manual without notice.