











# Off-Grid Power Inverter User Manual

---

RS-V1000  
RS-V1500  
RS-V2000  
RS-V3000

## AVAILABLE PIUGS AND SOCKETS

PIUGS			
			
Universal	Australia	France&Germany	Italy
			
Small Europe Type	South Africa	UK	USA

SOCKETS			
			
Australia	Europe&USA&Japan	France	Germany
			
GFCI-USA	UK	Universal	USA

## PREFACE

### Preface

Thank you for purchasing our Power Inverter. This is a compact and highly portable power inverter which has an excellent track record in the field of high frequency inverters. From the 12V DC outlet in your applications e.g., vehicle or boat, or directly from a dedicated 12V DC battery, this inverter can efficiently and reliably power a wide variety of household AC products, such as TV, Computers, Air-conditioning units etc.

Please read this guide before installing or using the inverter and save it for future reference.

Due to our continuous work to upgrade and improve our products, we may change or revise the contents of this manual instructions or any part of it without giving any further notice



**⚠ CAUTION! Do not use the inverter with the following equipment**

1. Small battery-operated products such as rechargeable flashlights, some rechargeable and nightlights that are plugged directly into an AC receptacle to recharge.
2. Certain battery chargers for battery packs used in hand-powered tools. These charger's will have warning labels stating that dangerous voltages are present at the charger's battery terminals.
3. Note DC voltage of battery should be similar to input DC voltage of power inverter (e.g. DC voltage should be similar (within spec) to the Inverter input voltage)

### 3. PRODUCT FEATURES AND APPLICATIONS

#### Product Features

- Pure sine wave or modified sine wave
- Soft start
- PWM (Pulse Width Modulation)
- Microprocessor based design
- With power ON/OFF switch and LED indicator
- Overload protection / Over voltage protection / Short Circuit protection / Over temperature protection / Reverse polarity protection (by fuses)

#### Product Applications

- Power tools; Electric Saw, Drilling Machine, Grinder, Sand blast Machine, Punching Machine, Weeding Machine, Air Compressor etc.
- Office Applications; Computer, Printer, LCD Monitor, Scanner etc.
- Household Appliance Applications; Vacuum Cleaner, Fan, Lamp or LED, Sewing Machine etc.
- Kitchen Appliance Applications; Microwave, Fridge, Freezer, Coffee maker etc.

### 4. PURE SINE WAVE AND MODIFIED SINE WAVE INVERTERS

The inverter comes in two types:

pure sine wave power type and modified sine wave type. In the pure sine wave power inverter, the 240V AC output follows a smooth Sinusoidal sine wave and is almost identical to normal mains electricity.

A Graphic Comparison of Modified Sine Wave and Pure Sine Wave is shown below:

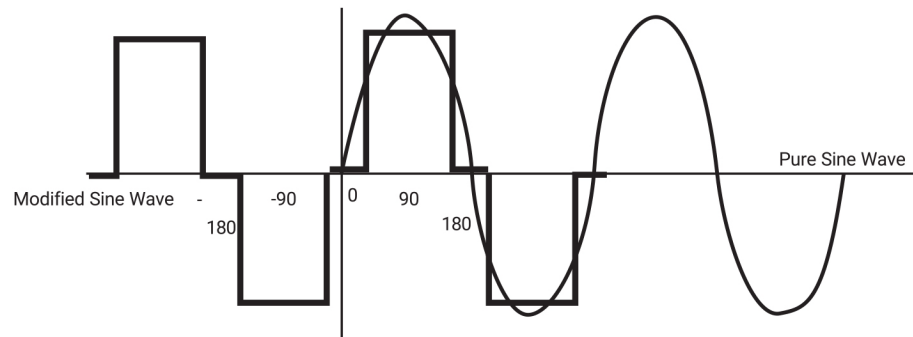

### 5. GUIDELINES

#### Installation Conditions

For safe and optimum performance install the inverter in a location that is:

1. Dry-Do not expose to water drips or spray.
2. Cool-Operate only in ambient temperatures between 32F (0°C) and 104F (40°C). Keep away from heating vents or other heat producing equipment.
3. Safe-Do not install inverter in a compartment with batteries or flammable liquids, such as gasoline or explosive vapors.
4. Well ventilated-Allow at least 2 inches (5cm) clearance above and on all sides of the unit for proper cooling.
5. Clean and free of dust and dirt-This is especially important if the inverter is used in a dusty working environment. Select a Suitable Location.

#### ⚠ Working Principle

The inverter works in two stages. During the first stage, the DC to DC converter increases the DC input voltage from the power source (e.g., A 12V battery) to 300V DC In the second stage, the high voltage DC is converted to the watts (power) you need (AC) using advanced power MOSfet transistors or IGBT technology in a full bridge configuration. The result is excellent overload capability and the capacity to operate difficult reactive loads Connection Method

#### ⚠ CAUTION!

A reverse polarity connection (positive to negative) may damage the inverter (Fuse) Damage caused by a reverse polarity connection would probably invalidate your warranty.

#### ⚠ WARNING: Sparking may occur when connecting the DC supply unit to the battery, make sure no flammable fumes are present before making any connections.

1. Attach the ring type connector marked with red to the positive (+) DC terminal on the inverter and attach the ring connector marked with black to the negative (-) DC terminal.
2. Tighten both DC terminals by hand until tight. If the power is more than 1800w, please use tools to tighten up the screw.
3. When the inverter is not in use, unplug it from the 12V DC outlet to avoid any battery discharge.

#### Battery's Charge

We advise that you use a deep cycle battery. If you hear the low voltage alarm, stop the inverter immediately. When the battery is fully charged, the inverter can be used again. It is not recommended to use from a vehicle battery.

## Inverter's Working Status

1. When a 12V DC outlet or battery is properly connected to the inverter, turn on the ON/OFF, the green Power indicator will light, and it deliver AC power to the outlets.
2. Plug the AC appliances you wish to operate into the AC outlet (s) and switch your appliances on, switch one at a time.
3. If the audible alarm is ignored the inverter may be automatically shut down when the battery voltage drops to 9.8-10.2V in order to prevent damage to the battery from excessive discharge.
4. If the AC appliances rated power is higher than inverters rating (or the appliance draws excessive surge power) the inverter will shut down. The red FAULT indicator will light.
5. If the inverter exceeds a safe operating temperature, due to insufficient ventilation or a high surrounding temperature, it will automatically shut down. The FAULT indicator will light, and the audio warning alarm will sound.
6. If a defective battery charge system has caused the battery voltage to rise to a dangerously high level, the inverter will automatically shut down.
7. The cooling fan is designed to operate only when the temperature goes up or when the loads are applied.

**⚠ NOTICE: When you connect to the appliances, remember to turn on the inverter before turning on the appliance.**

**⚠ CAUTION: Although the inverter incorporates the protection function against over-voltage, there would be still the possibility of getting the unit damaged if the input voltage exceeds 16V.**

## 6. INVERTER IMAGES

### ① Modified sine wave 300W-600W

Power (Green) and Fault (Red) Indicate

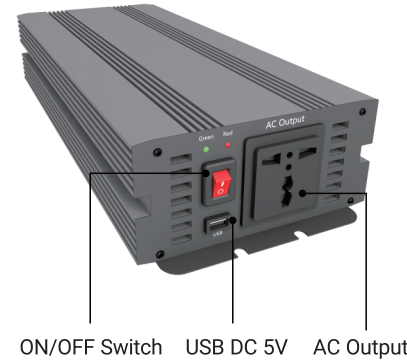

### ② Pure sine wave 300W-600W

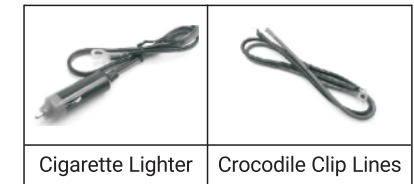
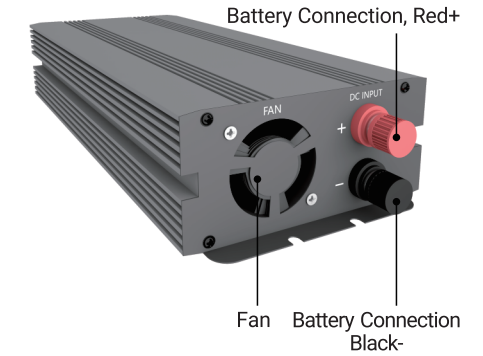

### ③ Modified sine wave 1000W-2000W

Light Indicators Power (Green) and Fault (Red)

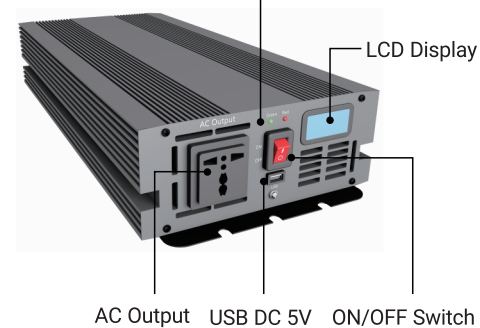

### ④ Pure sine wave 1000W-2000W

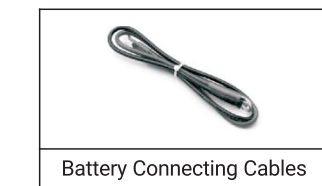
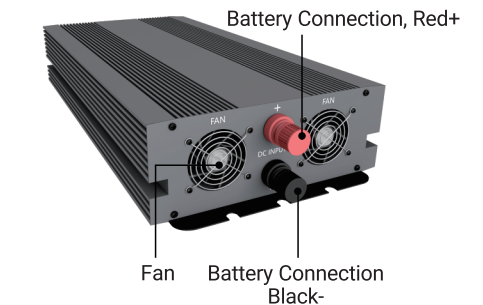

⑤ Modified sine wave 3000W-6000W

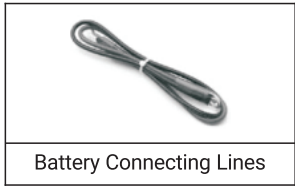
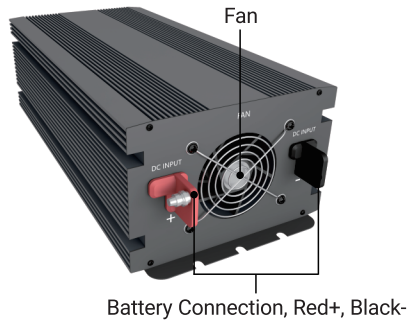

⑥ Pure sine wave 3000W-6000W

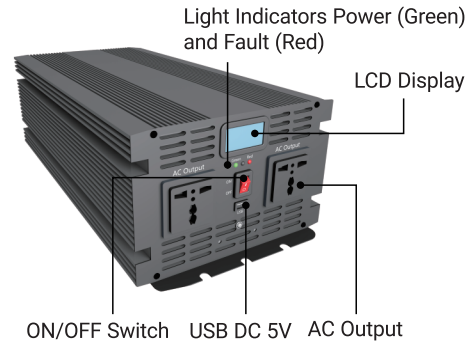

7. INVERTER TO BATTERY CONNECTIONS DETAILS

12V inverter connection

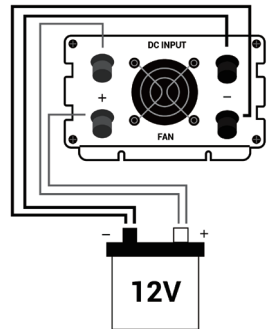

Outputs connection

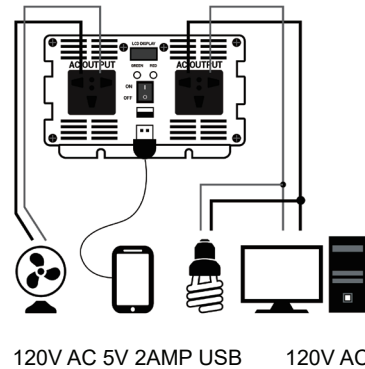

8. TROUBLE SHOOTING

⌘ AC appliances do not work, and the green power indicator does not light.

CAUSES	SOLUTION
Bad battery	Check the battery, replace it if necessary
Reverse connection of negative and positive poles	Correct the connection to battery, the inverter may be damaged. Replace the fuse inside inverter (outside warranty coverage)
Loose connection of cables	Check the cables and the connection, screw tight the wiring terminal

⌘ The electric appliance does not work, and the red FAULT indicator of the inverter is lit.

CAUSES	SOLUTION
Overload shut off due to rated power of appliances exceeding the inverter's rated power	Use appliances having power below the inverter's rated power
Overload shut off due to a too high surge current	Increase inverter power

CAUSES	SOLUTION
The battery is over discharged (inverter sounds an alarm)	Replace the battery or use battery charger to charge your battery
Over temperature shut off due to bad ventilation	Switch off the inverter and let it cool for 15 minutes. Clear objects around the fan and the inverter. Place the inverter in a cool place. Reduce load according to requirements. Restart
Too large input current	Check the working state of the charging system. Make sure the output voltage of the battery is within the proper voltage

⌘ The measured output current of the inverter is too low	
CAUSES	SOLUTION
Amp is too low	Measure modified sine wave with a real effective value multimeter to get the accurate data
Amp supplied is too low	Charge the battery or change battery
⌘ The inverter gives out alarm sound.	
CAUSES	SOLUTION
Low voltage alarm (Voltage Drop)	Shorten the wire or use wider cable. Charge the battery.
Over temperature protection (Component Temp / Ambient Temp)	Allow the Inverter to cool. Improve ventilation around the inverter.
AC appliances draw too much power	Use larger capacity inverter.
Poor connection	Check the connection and tighten it.

## 9. SPECIFICATIONS

ITEMS	1000	1500	2000	2500	3000
<b>RATED POWER</b>	1000W	1500W	2000W	2500W	3000W
<b>SURGE POWER</b>	2000W	3000W	4000W	5000W	6000W
<b>OUTPUT VOLTAGE</b>	AC110V ± 10%				
<b>INPUT VOLTAGE</b>	12V	12V	12V	12V	12V
<b>OUTPUT WAVEFORM</b>	Pure sine wave or Modified sine wave				